



European
Commission

JRC SCIENTIFIC AND POLICY REPORTS

Best available technologies for the heat and cooling market in the European Union



SETIS
Information For Decision-making

Nicolas Pardo Garcia, IET-JRC
Kostantinos Vatopoulos, IET-JRC
Anna Krook Riekkola, IET-JRC, Luleå University of Technology
Alicia Perez Lopez, IET-JRC
Lars Olsen, Danish Technology Institute

2012



Source: www.euroheat.org

Report EUR 25407 EN

Joint
Research
Centre

European Commission

Joint Research Centre
Institute for Energy and Transport

Contact information

Christian Thiel
Address: Joint Research Centre, Westerduinweg 3, NL-1755 LE Petten, The Netherlands
E-mail: christian.thiel@ec.europa.eu
Tel.: +31 (0)224565143
Fax: +31 (0)224 565600

<http://iet.jrc.ec.europa.eu/>
<http://www.jrc.ec.europa.eu/>

This publication is a Reference Report by the Joint Research Centre of the European Commission.

Legal Notice

Neither the European Commission nor any person acting on behalf of the Commission is responsible for the use which might be made of this publication.

Europe Direct is a service to help you find answers to your questions about the European Union
Freephone number (*): 00 800 6 7 8 9 10 11

(*): Certain mobile telephone operators do not allow access to 00 800 numbers or these calls may be billed.

A great deal of additional information on the European Union is available on the Internet.
It can be accessed through the Europa server <http://europa.eu/>.

JRC 72656

EUR 25407 EN

ISBN 978-92-79-25608-0

ISSN 1831-9424

doi: 10.2790/5813

Luxembourg: Publications Office of the European Union, 2012

© European Union, 2012

Reproduction is authorised provided the source is acknowledged.

Printed in Petten the Netherlands

General Index

1. INTRODUCTION	7
2. DISTRICT HEATING AND COOLING TECHNOLOGIES	10
2.1. Solar district heating	10
2.2. Seasonal storage	12
2.3. Electric boilers	14
2.4. Heat pump	15
2.5. Waste to Energy District Heating Plant	18
2.6. Wood chips (District heating boiler, wood chips fired)	20
2.7. Natural gas (District heating boiler, gas-fired)	21
2.8. Geothermal	22
2.9. Combined heat and power	24
2.10. District Cooling	25
3. INDUSTRIAL TECHNOLOGIES	26
3.1. Industrial heat processes	27
3.2. Industrial cold processes	29
4. SERVICE AND RESIDENTIAL TECHNOLOGIES	31
4.1. Gas (and oil) boilers	31
4.2. Thermal solar heating systems	34
4.3. Comfort cooling in buildings	35
4.4. Heat pumps	38
4.5. Development of cost and performance	41
5. AGRICULTURE AND FISHERY TECHNOLOGIES	42
6. CONCLUSIONS	43
7. REFERENCES	44

Index of tables

Table 1: Arguments for the selection of BATs.....	9
Table 2: Technology and cost characteristics of small and large CHP technologies in 2007	25
Table 3: Most common fuel used in the industrial boilers (ref. /17/)	27
Table 4: Load profiles – Gross heat load for various types of gas boilers.....	32
Table 5: Default capacity and efficiency values of base cases, as determined in task 5 (ref. /9/)...	37
Table 6: Average product price per unit for the base-cases	37
Table 7: Average installation cost per unit.....	37
Table 8: Technology and cost characteristics of heat pumps for heating and cooling in single-family dwellings in 2007 (ref. /10/)	41
Table 9: Cost and performance goals for heating and cooling technologies, 2030 and 2050 (ref. /10/).	42

Index of figures

Figure 1: Evolution up to 2050 of the useful energy for heat demand for EU27 for baseline scenario, scenario A and scenario B.....	8
Figure 2: Example of a solar collector field with pit storage (ref. /5/)	11
Figure 3: Example of a solar district heating system	11
Figure 4: Illustration of seasonal thermal energy storage – concepts (ref. /4/)	12
Figure 5: Investment costs of seasonal heat stores in Germany GRP: Glass-fiber reinforced plastic. HDC: High-density concrete (ref. /4/)	13
Figure 6: Illustration of a hot water boiler (reg. /24/)	14
Figure 7: Process diagram of the mechanical driven heat pump (ref. /7/)	15
Figure 8: Process diagram of absorption heat pump compression cycle (ref. /7/)	16
Figure 9: Illustration of an incineration plant (ref. /26/)	19
Figure 10: Illustration of a district heating boiler with flue gas condensation (ref. /25/)	20
Figure 11: Illustration of district heating boiler, gas-fired (ref. /28/)	22
Figure 12: District heating base on geothermal sources (ref. /4/)	23
Figure 13: Illustration of a system with an absorption heat pump (Ref. /4/)	23
Figure 14: Illustration of a district cooling system (ref. /27/)	26
Figure 15: Example of boiler used for solid biomass and other feedstock (ref. /23/)	27
Figure 16: Simplified cement production process (ref. /22/)	28
Figure 17: Illustration of a heating system with a gas boiler	33
Figure 18: Figure showing an example of the annual variation in solar irradiation and energy consumption for space heating	34
Figure 19: Illustration of a solar thermal heating system	35
Figure 20: Central cooling system with the building being cooled through ventilation shafts.	36
Figure 21: Central cooling system with the building being cooled through a closed water loop. ...	36
Figure 22: Split cooling system - Typical one external part and one internal part for each room ...	36
Figure 23: Illustration of a ground source closed loop brine/water heat pump (ref. /17/)	39
Figure 24: Illustration of an exhaust air/water heat pump (ref. /17/)	39
Figure 25: Illustration of an ambient air/water heat pump (Ref. /17/)	40
Figure 26: Illustration of an ambient air/air heat pump (ref. /17/)	40

1. Introduction

Every year, over 40% of the total energy consumed in Europe is used for the generation of heat for either domestic or industrial purposes whereas the cooling demand is growing exponentially (ref. /1/). The importance of the heat and cooling sector is underlined in the EU energy policy initiatives (ref. /2/, /3/). This emphasizes the role of technologies based on renewable energy sources combined with high-efficiency energy technologies, to meet the heat and cooling demand in Europe more sustainably in the future. In this context, it is essential to identify the current and future heat and cooling demand and the technologies employed in the domestic, commercial and industrial sectors of the EU.

The European Commission's Strategic Energy Technologies Information System led and coordinated by the Joint Research Centre recently finalised a study, which was undertaken with two partners¹, on the European heat and cooling market and its technology mix. The study was performed under the auspices of the Energy System Evaluation Unit of the Institute of Energy and Transport of the JRC. The study characterises the current heat and cooling market in each of the EU27 Member States, Switzerland and Norway, it quantifies the future heat and cooling demand, reviews end-use technologies and qualifies the technology innovation that could take place in this sector.

The full study has resulted in the creation of a (i) database with description and quantification of the current status of the European heat and cooling demand market by country, useful and primary energy demand by fuel and state of the art of the technology portfolio, (ii) a database mapping the key technologies for improving the energy efficiency and reducing CO₂ emissions within the heat and cooling market, as well as potential technology innovation and its barriers, and (iii) a modelling tool to develop scenarios of the evolution of the heat and cooling demand up to 2050.

The present report provides an overview of the technologies that are included in the technology database. The technology descriptions are divided into sections covering technologies for district heating including combined heat and power generation, industrial technologies, service and residential technologies and finally agriculture and fishery technologies.

The technologies shown in this report are characterised as Best Available Technologies (BAT), which are technologically innovative techniques, economically viable for the specific field in question. The selection was carried out by an interdisciplinary expert team. The information given is fully referenced. The descriptions of the technologies include the advantages and disadvantages. Table 1 lists the reasons why the different technologies have been characterised as BAT.

The technology database contains specific techno-economic information such as capacity range, performance, cost and potential barriers for deployment up to 2050 for the BATs described in this document. This database in combination with the market database can be used in a modelling tool to study scenarios for the evolution of the heat and cooling demand at country level up to 2050 and it can estimate the variation in the useful and primary energy demand for the heat or cooling market due to different scenarios of energy efficiency improvements and the technology deployment mix in the European market. As an illustrative example of typical outputs of this modelling tool Figure 1 shows results obtained for the evolution up to 2050 of the useful energy

¹ BIO Intelligence Service and Danish Technological Institute (DTI)

for heating demand for the EU for three different scenarios: baseline scenario (current trend according to the EU trends 2009, DG ENER), scenario A (penetration of BAT 50% higher than in the baseline scenario) and scenario B (penetration of BAT two times higher than the baseline scenario). These results show a reduction of the useful energy demand of around 7% and 11% for the scenario A and scenario B respectively compared with the baseline scenario in 2050. Furthermore they also show changes in the shares of the final energy demand, reflecting a different technology portfolio mix in the different scenarios.

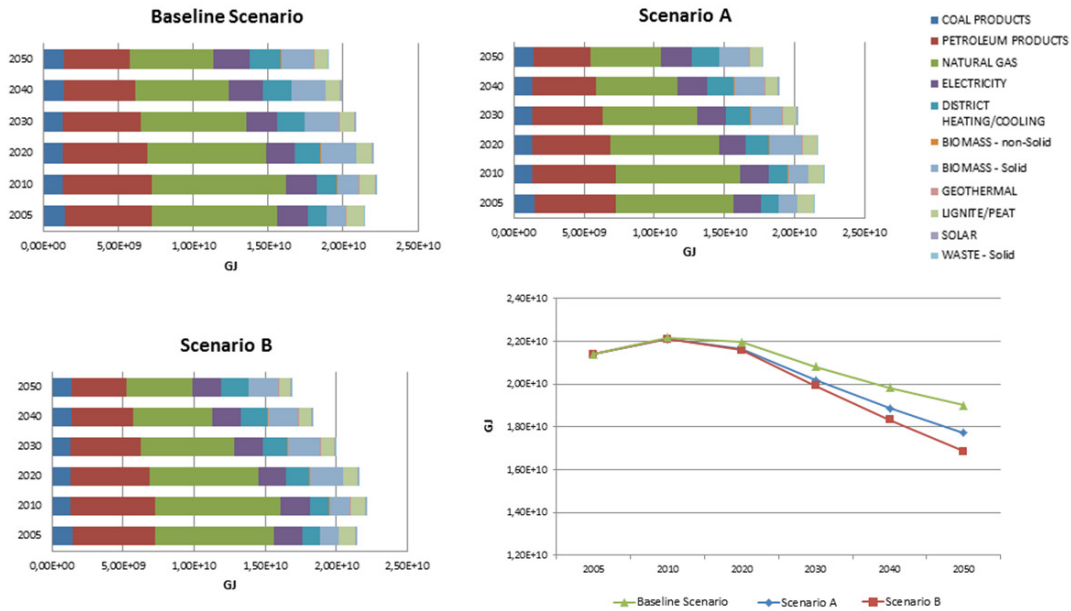

Figure 1: Evolution up to 2050 of the useful energy for heat demand for EU27 for baseline scenario, scenario A and scenario B.

Table 1: Arguments for the selection of BATs

Section	Technology	Arguments for selection as BAT
2.	District heating and cooling technologies	
2.1.	Solar district heating	Renewable and CO ₂ free energy source.
2.2.	Seasonal storage	Supports a renewable and CO ₂ free energy source (solar energy).
2.3.	Electric boilers in district heating	Utilise superfluous electric energy for heating when the electric production is very high
2.4.	Heat pump for district heating	Produce heat with a high energy efficiency
2.5.	Waste for District heating	Uses waste for energy production, which is partly renewable, and has therefore reduced CO ₂ emissions
2.6.	Wood chips	Uses a CO ₂ neutral energy source
2.7.	Natural gas	Flexible, reliable and economical to use as backup capacity in district heating systems.
2.8.	Geothermal	Nearly a CO ₂ free energy source. Can be used in combination with heat pumps and as energy storage for solar energy
2.9.	Combined heat and power	Produce energy with a high energy efficiency due to the combination of both heat and power.
2.10.	District cooling	Can be more efficient than individual cooling systems. Can have a large efficiency when combined with district heating and absorption chillers
3.	Industrial technologies	
3.1.	Natural gas boilers for industry	High utilisation of energy input. Emissions can be low using the right technologies.
3.1.	Oil boilers for industry	High utilisation of energy input. Emissions can be low using the right technologies.
3.1.	Biomass boilers for industry	Uses a CO ₂ neutral energy source
3.1.	Economizers for boilers for industry	Increases the energy efficiency
3.1.	Heat pumps for industry	Produce heat with a high energy efficiency
3.2.	Thermally driven cooling	Utilises waste heat for producing cooling
3.2.	Mechanically driven compression cooling	Produces cooling with a high energy efficiency
3.2.	Free cooling, seawater	Produces cooling from a renewable and CO ₂ free resource at nearly no energy cost. Only slightly exposed to yearly temperature changes
3.2.	Free cooling, groundwater	Produces cooling from a renewable and CO ₂ free resource at nearly no energy cost
3.2.	Cooling tower	Produces cooling from a renewable and CO ₂ free resource at nearly no energy cost. Very exposed to changes in weather
4	Service and residential technologies	
4.1.	Condensing gas boilers	Larger efficiency than traditional boilers. Large flexibility and have benefits when used as a backup system
4.2.	Solar heating	Renewable and CO ₂ free energy source, but has limitations in applicability
4.3.	Central cooling system	The systems of this category produce cooling with a high

Section	Technology	Arguments for selection as BAT
	– comfort cooling	efficiency. Centralising the cooling system provides for the ability to reach an overall higher efficiency compare to split cooling systems in separated rooms. If the electricity is supplied from solar cells it is possible to use a renewable and CO ₂ free energy source for the provision of thermal comfort.
4.3.	Split cooling system - Comfort cooling	The systems of this category produce cooling with a high efficiency. If the electricity is supplied from solar cells it is possible to use a renewable and CO ₂ free energy source for the provision of thermal comfort
4.4.	Ground source closed loop brine/water heat pump	Produces heat with a high energy efficiency, but needs sufficient ground area
4.4.	Exhaust air/water heat pump	Produces heat with a high energy efficiency, but has limitations in applicability due to a limited amount of exhaust air
4.4.	Ambient air/water heat pump	Produces heat with a relative high energy efficiency. Independent of availability of sufficient ground area
4.4.	Ambient air/air heat pump	Produce heat with a relative high energy efficiency. Independent of availability of sufficient ground area, but might have a limited applicability
5.	Agriculture and fishery technologies	
5.	Heat pumps for heating and cooling in agriculture	Produces heat and cold with a high energy efficiency

2. District heating and cooling technologies

This section provides a short description of the selected technologies for the district heating and cooling applications. For the large systems, most of the information is derived from the Technology Data for Energy Plants (ref. /4/).

2.1. Solar district heating

► Description of technology

This type of technology is related to large installations, which are used for producing heat for district heating systems. Solar heating systems use solar collectors and a liquid handling unit to transfer heat to the load generally by using storage. This system needs additional heat generation capacity to ensure that all the heating needs of the consumers are met in periods with insufficient sunshine or during wintertime. This additional heat can be obtained by heat-only boilers or by combined heat and power plants (CHP).

One of the described systems relates to a system without a thermal storage. The other system with storage has a diurnal storage in the range of 0.1 – 0.3 m³ pr. m² solar collector and covers 10 – 25 % of the annual heat demand.

► Diagram of the system

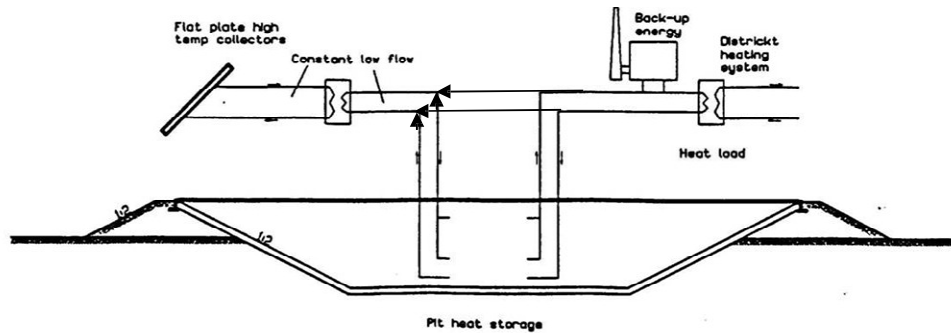

Figure 2: Example of a solar collector field with pit storage (ref. /5/)



Figure 3: Example of a solar district heating system

► Description of the components

The main components of this system are (see Figure 2 and Figure 3):

- Solar collectors;
- District heating system;
- Back up heating system;
- Possibly of heat storage.

► Brief description of the different types

The solar collectors are typically highly efficient collectors (e.g. flat plate collectors).

There are more efficient solar collector systems such as the concentrating systems, which use different types of mirrors. These systems can generate higher temperatures and are typically used for power generation or high-temperature applications in areas with a high level of direct solar irradiance.

Ref /4/ states that a typical annual solar collector output is 500 kWh/m^2 when it is placed in a Danish location. The cost of the collector and pipes is 200 €/m^2 . The cost for the total system without a heat storage is 440 €/m^2 . With a diurnal storage the cost is 480 €/m^2 .

► Advantages and disadvantages

The advantage of the system is that it uses a CO₂ free energy source. The efficiency is higher if the temperature level of the district heating system is relatively low. Due to the climatic variations during the year, it is less cost effective to have 100% coverage of the heating demand than to have part load coverage. For example in Denmark, this system can cover between 10 % and 25 % of the annual heating demand.

The main disadvantage is its high investment cost as shown above. The technology without a seasonal storage needs a backup energy source, which can be based on biofuels, waste, or fossil fuels as natural gas, oil or coal. Other possibility is the cogeneration with heat and power (CHP) or the use of heat pumps.

2.2. Seasonal storage

► Description of the technology

This technology addresses long-term (seasonal) heat storage for district heating systems. The described technology covers storage in a water pit. This technology is selected as the most cost effective for large volumes (See Figure 4).

► Diagram of the technology

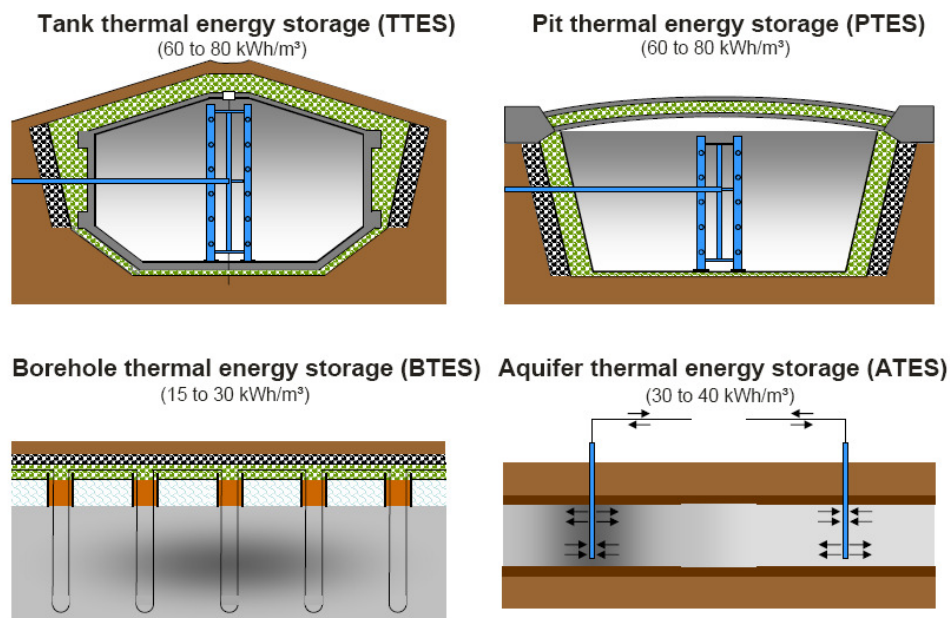

Figure 4: Illustration of seasonal thermal energy storage – concepts (ref. /4/)

► Description of the components

Figure 4 and Figure 5 show the different possibilities for the construction of seasonal storages .

Hot water tanks (TTES) have been used in Germany for sizes of up to 12.000 m³. These tanks are normally constructed from concrete or steel, and are relatively expensive compared to constructions in which the ground is used as a structural or thermal component. Their advantage is that their properties are easier to control and the tightness is better because they are not influenced by the local soil conditions.

A water pit (PTES) is essentially an opening in the ground lined by a waterproof membrane, filled with water and covered by a floating and insulating lid. The excavated earth that surrounds the opening can be used as a dam, thus increasing the water depth. The storage capacity is 60 – 80 kWh/(m³·a). This type of storage has e.g. been realized in the large Marstal Solar District Heating system (Denmark). One of the challenges of this type of storage is maintaining the membrane 100 % watertight over many years of thermal cycling. The ground water flow can cause heat loss, since this type of storage sometimes is not (well) insulated at the bottom. The omission of bottom/side insulation is possible due to the high volume/surface ratio in very large systems.

For storage of solar heat only, a solar collector of approximately 4 m² per m³ is needed. The temperature interval of 85-90 °C covers a large storage. The efficiency of 80 % (56 kWh/ (m³·a)) is achieved without a heat pump and increases to 95 % (67 kWh/ (m³·a)) when a heat pump is used to discharge the storage.

Another possible technology is the application of tubes in boreholes (BTES). They are typically used with heat pumps and they operate at low temperatures (0 to 30 °C). The storage can reach efficiencies in the range of 90 to 100 % when the storage operates around the annual average temperatures of the ground and there is no strong natural ground water flow. This type of thermal storage is sometimes also used as a heat sink in comfort cooling systems.

Underground aquifers (ATES) are constructed by using direct heat exchange in vertical wells. Typically, there is one central well which is surrounded by a number of peripheral wells. The aquifers are typically used for low-temperature applications in combination with heat pumps for cooling during summer and heating during winter. A potential problem is the chemical composition of the water in the aquifer, which might affect the performance.

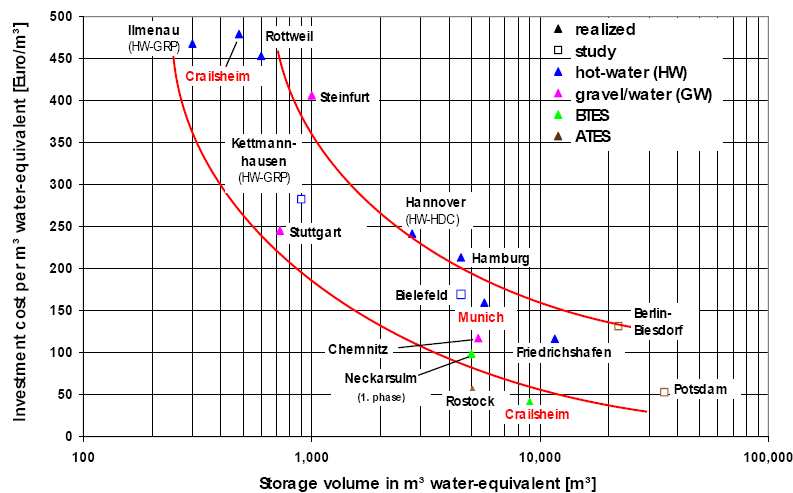

Figure 5: Investment costs of seasonal heat stores in Germany GRP: Glass-fiber reinforced plastic. HDC: High-density concrete (ref. /4/)

► Advantages and disadvantages

The advantage of the system is that it uses a CO₂ free energy source. The disadvantage is its high investment cost. In addition, this technology needs a large seasonal storage to limit the heat loss from the storage.

2.3. Electric boilers

► Description of the technology

An electric boiler is used for producing hot water directly from electricity (see Figure 6). Two types of installations are available:

- Heating elements using electrical resistance (same principle as a hot water heater in a normal household).
- Heating elements using electrode boilers. The principle is that the water in the boiler is heated by an electrode system with three phase electrodes. The current from the phase electrodes flows directly through the water, which is heated in the process.

► Diagram of the system

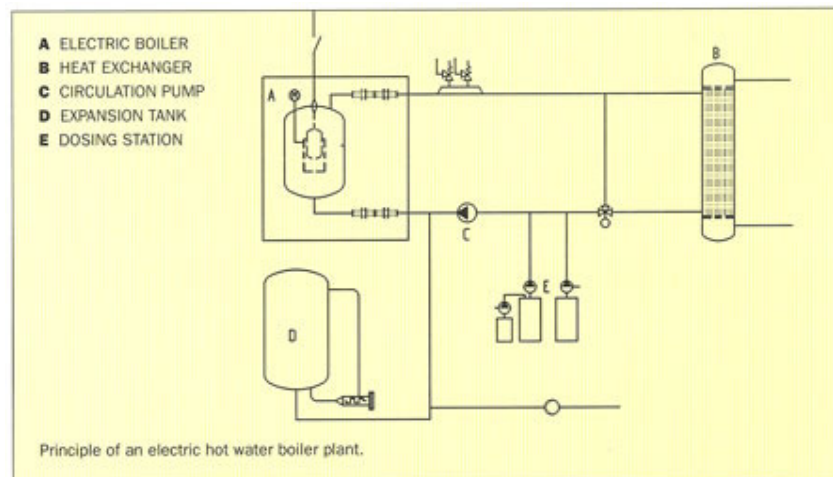

Figure 6: Illustration of a hot water boiler (reg. /24/)

► Description of the components

Typically, electrical resistance is used for smaller applications up to 1-2 MW's. These electric boilers are connected at 400 V. Electrode systems are used for larger applications (larger than a few MWs up to 25 MW). Larger electrode boilers (larger than a few MWs) are connected at 10 kV. The efficiency of both types of electric boilers is 99 %.

It is possible to use different types of electric boilers in applications in the residential area, district heating and industries. The temperature range is flexible. It is possible to install applications in industries that produce steam.

► Advantages and disadvantages

The advantage of the system is that it can use excess of electric energy when the production of electricity is very high, e.g. when there is a large electricity production from wind turbines. It has a simple design and is easy to regulate. The disadvantage is that this solution has limited use because the electricity production is normally oriented to cover the needs for other uses instead of this one.

The electric system is suitable for smaller installations with lower voltages and power capacities while the electrode boiler system is suitable for larger installations with higher voltages and power capacities due to lower installation expenses.

2.4. Heat pump

► Description of the technology

Heat pumps employ the same technology as refrigerators, moving heat from a low-temperature location to a warmer location. Heat pumps usually draw heat from the ambient (input heat) and convert the heat to a higher temperature (output heat) through a closed process; either compressor heat pumps (consuming electricity) or absorption heat pumps (using heat; e.g. steam, hot water or flue gas). Absorption heat pumps use high-temperature heat for operating the process instead of electrical energy. Absorption heat pumps incorporate low-temperature energy and convert it to a higher temperature as well as mechanically driven heat pumps. The drive energy for the absorption heat pumps can come from a number of different sources such as solid fuels (hard coal and derivatives, oil, renewable biofuels, other renewable energies (solar or geothermal), wastes (charcoal, MSW and industrial wastes), natural gas or derived gases. For the low-temperature heat source, one of the most obvious possibilities is to use residual heat from other processes.

The heat pump technology may have low CO₂ emissions if the efficiency is high and in the case of electrically driven heat pumps, if the electricity is produced with a large part of renewable energy. In the case of absorption heat pumps, if the energy supply is energy with low CO₂ emissions.

► Diagram of the system

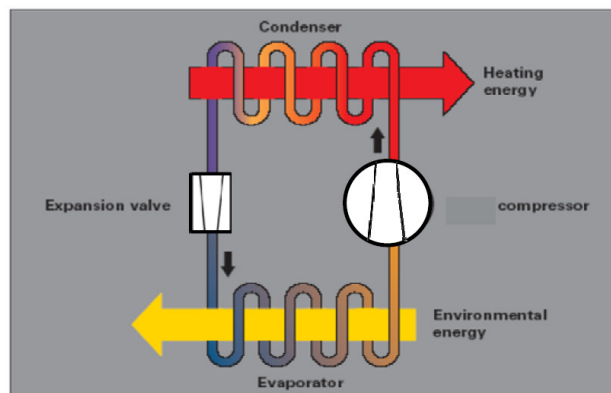

Figure 7: Process diagram of the mechanical driven heat pump (ref. /7/).

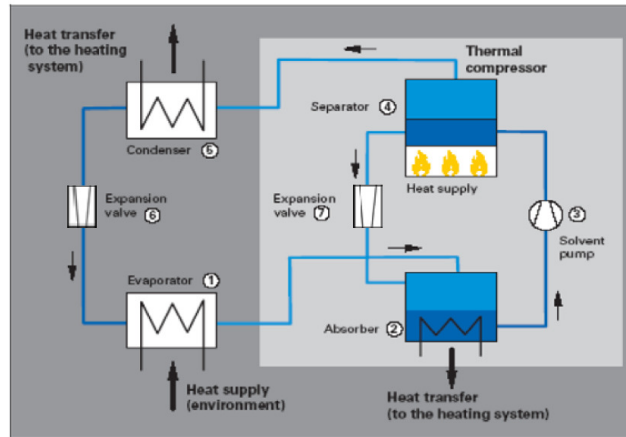

Figure 8: Process diagram of absorption heat pump compression cycle (ref. /7/).

► Description of the components

The most common types of heat pumps use either the vapour compression cycle or the absorption cycle.

In the heat pumps with a *vapour compression cycle* the main components are the compressor, the expansion valve, and two heat exchangers called the evaporator and the condenser. The principle is shown in Figure 7. A working fluid (refrigerant) is circulated through the four main components. In the evaporator, the working fluid is heated by the heat source (e.g. the ground, water or air) which enables the working fluid to evaporate. This vapour is compressed to a higher pressure and temperature. The hot vapour enters the condenser, where it condenses and releases heat, which can be used. The working fluid is then expanded in the expansion valve and returns to the evaporator and a new cycle can start. The compressor can be driven by an electric motor or a combustion engine.

Different working fluids are available all having advantages and disadvantages. Choosing the correct working fluid will depend on the specific application and no single fluid is preferred in all applications. Currently, CO₂ and ammonia are the two mainly used refrigerants for high capacity heat pumps.

A CO₂ based heat pump can be used for applications with temperatures up to 90 °C whereas new ammonia systems are capable of reaching temperatures of up to 100° C. There is no general price difference between the two system types.

The heat pumps using the *absorption cycle* are thermally driven instead of mechanically driven (see Figure 8). Often the absorption heat pumps for space heating are driven by gas while industrial applications are driven by high-pressure-steam or waste heat.

Absorption systems use the ability of liquids or salt to absorb vapour. The most common pairs for working fluid and absorbent are respectively:

- Water and lithium bromide
- Ammonia and water

The compression of the working fluid is achieved in a solution circuit, which consists of an absorber, a solvent pump, a thermal compressor and an expansion valve. Vapour at low pressure from the evaporator is absorbed in the absorber, which produces heat in the absorber. The

solution is pumped to high pressure and transported to the thermal compressor, where the working fluid evaporates (transformed to vapour) with the assistance of a high-temperature heat supply. The vapour is condensed in the condenser while the absorbent is returned to the absorber via the expansion valve.

Heat is extracted from the heat source in the evaporator. Heat at medium temperature is released from the condenser and absorber. High-temperature heat is provided in the thermal compressor (generator) to run the processes. A pump is also needed to operate the solvent pump but the electricity consumption is relatively small for that purpose (< 1 % of drive energy).

The input to the absorption cycle heat pumps is a heat source (e.g. ambient air, water or ground, or waste-heat from an industrial process) and energy to drive the process. The delivery temperature is depending on the heat source temperature and on the drive energy. In principle, the heat pumps can deliver temperatures of up to 94 °C. In practice, the temperature should not exceed 85 – 87 °C.

Several types of this kind of these installations are available:

- Large heat pumps for district heating systems, heat source ambient temperature. Supply temperature 80 °C. The typical capacity is 1 to 10 MW of generation heat. It is assumed that it is a mechanical compression type compressor with a CO₂ refrigerant. The COP² is estimated to be 2.8 but can be larger - up to 3.5. The investment cost is estimated to be 0.5 – 0.8 M€ per MW heat output.
- Large heat pumps for district heating systems, heat source 35°C, which might be industrial waste heat. Supply temperature 80 °C. The typical capacity is 1 to 10 MW of heat generations. It is assumed that it is a mechanical compression type compressor with a NH₃-refrigerant. The COP is estimated to be 3.6 but can be larger - up to 4.5. The investment cost is estimated to be 0.45 – 0.85 M€ per MW heat output.
- Large absorption heat pumps – flue gas condensation in connection with MSW and biomass plants which are non-fossil based energy sources but e.g. natural gas might also be used (steam driven). They are used to raise the district heating temperature from 40 °C – 60 °C to about 80 °C. It is assumed that it is an absorption type compressor with most commonly BrLi-H₂O as refrigerant. The typical capacity is 2 to 15 MW of heat generation. The COP is 1.7 and the investment cost is estimated to be 0.35 – 0.4 M€ per MW heat output. The investment cost for the heat pump alone is estimated to be 0.15 – 0.2 M€ per MW heat output.
- Large absorption heat pumps – geothermal heat source (steam driven). Geothermal water is used to heat water for a district heating system from about 40 °C to about 80 °C. It is assumed that it is an absorption type compressor with as most common BrLi-H₂O as refrigerant. The typical capacity is 2 to 15 MW of heat generation. The COP is around 1.7 and the investment cost is estimated to be 0.4 – 0.5 M€ per MW heat output.

► Advantages and disadvantages

² COP: Coefficient of performance of a heat pump

The advantage of a heat pump system is that it incorporates waste or free energy and transforms it to a higher temperature, which is useful for the specific application. The disadvantage is the energy needed for the transformation (electricity or high-temperature heat) and the cost of the necessary equipment. The advantage of the electrically driven heat pumps compared to absorption heat pumps is a higher efficiency. However, heat used to run the absorption heat pumps could be achieved at a lower cost making this option favourable in some applications as when e.g. industrial waste heat can be applied. The investment costs per produced heat output are lower for the referenced absorption heat pumps than for the mechanical driven heat pumps.

2.5. Waste to Energy District Heating Plant

► Description of the technology

The major components of the system are illustrated in Figure 9: a waste reception area (1), a feeding system (2), a grate fired furnace interconnected with a hot or warm water boiler (4, 6, 7, 8), an extensive flue gas cleaning system and systems for handling combustion and flue gas treatment residues (10, 11, 12, 13,14). If the process is combined with electricity production a steam turbine (9) is used.

Waste comes primarily from industrial and household waste. Trash is collected in a silo. A crane dumps the waste into the incinerator. The incinerator is composed of a series of grates that constantly move to aid the combustion. Air under the grates and above the fire provides oxygen for the combustion process. The temperature in the incinerator is between 875 and 1100 °C. Pipes in the incinerator produce super heated steam, which can be used in a turbine to produce electricity. Excess heat is processed in a heat exchanger to warm up water and produce district heating.

The plant is primarily designed for incineration of municipal solid waste (MSW) and similar non-hazardous wastes from trade and industry. Some types of hazardous wastes may, however, also be incinerated. It is convenient to incinerate waste due to the control of the emissions and due to the production of heat for district heating and in some cases also electricity (CHP). A large part of the MSW is considered as renewable energy and therefore it replaces the consumption of fossil fuels. Incineration of waste also reduces the volume and the residues can be used for construction works. The disadvantage is the extensive treatment of the polluted flue gases. MSW waste materials are classified (ref. /19/) in different categories:

- Industrial wastes: Wastes of industrial non-renewable origin (solids or liquids) combusted directly for the production of electricity and/or heat. Renewable industrial waste should be reported in the Solid biomass, Biogas and/or Liquid biofuels categories.
- Municipal solid waste (renewable sources): Waste produced by households, industry, hospitals and the tertiary sector, which contains biodegradable materials that are incinerated at specific installations.
- Municipal solid waste (non-renewable sources): As MSW described above but contains non-biodegradable materials.

The efficiencies are based on net calorific values. The difference between the net and gross calorific values is due to the water formed during the combustion of the waste materials. If the water vapour is condensed, then the heat in the water content can be exploited. That can give plant efficiencies of around 100 %. The investment costs are estimated to be 1.1 M€/MW. The operation costs are estimated to be around 8 % of the investment costs. For example, in Copenhagen, the net heating value has increased from 9.8 kJ/kg to 10.5 kJ/kg between 2004 and 2008 and it is expected to increase to 11.5 kJ/kg by 2025 (ref. /4/).

The output water of the system can be classified according to its temperature as hot water (> 120 °C) or warm water (<120 °C). The high temperatures makes it possible to have combined heat and power generation and the hot water can be used for industrial applications, while water at the lower temperatures are primarily used for district heating.

► Diagram of the system

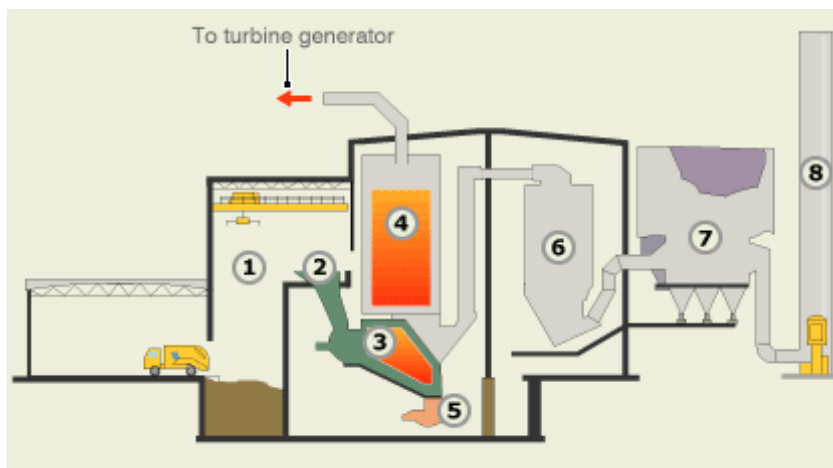

Figure 9: Illustration of an incineration plant (ref. /26/)³

► Advantages and disadvantages

The advantage of the system is that it uses waste as an energy source instead of using fossil fuels or other energy sources. As a significant part of the waste materials is renewable, that also leads to reduced CO₂ emissions. The disadvantage is the investment costs and that the technology is limited to the amount of collected waste. There has to be a systematic collection of waste, which should preferably be sorted in order to be incinerable by e.g. removing glass and metal bottles from the waste.

³Waste is tipped into a holding area (1) where it is picked up by grabs and dropped into a hopper (2). The waste is pushed gradually into the incinerator (3) which runs at a temperature of 750 degrees Celsius. Heat from the burning waste is used in a boiler (4) and steam from this is piped to a turbine generator to create electricity. The heaviest ash falls into a collection point (5) and is passed over with an electromagnet to extract metal content for recycling. Flue gases containing fine ash then pass through a scrubber reactor (6) to treat acid pollutants such as SO₂ and also dioxins. The gases then pass through a fine particulate removal system (7) and are released through the chimney stack (8).

2.6. Wood chips (District heating boiler, wood chips fired)

► Description of the technology

The wood-chips used in this technology derive from forestry and/or from wood industry. These sources include mainly waste materials, but it is also possible to use chipped energy crops (e.g. willow) or garden waste. The fuel is regarded as a renewable energy source and it is CO₂ neutral. The energy can be produced at costs similar to many other energy sources as e.g. natural gas.

If the moisture content of the fuel is above 30-35 %, it is possible to use flue gas condensation. In these cases, the thermal efficiency usually exceeds 100 % (based on lower heating value). The efficiency is primarily determined by the condensation temperature, which is a little above the return temperature from the district heating network. In well-designed systems, this return temperature is below 40 °C, yielding efficiencies above 110 %. The investment costs are estimated to be 0.3 to 0.7 M€/MW. The operation costs are estimated to be around 5 % of the investment costs for heat generating capacities between 1 to 50 MW. A diagram explaining the process is shown in Figure 10.

► Diagram of the system

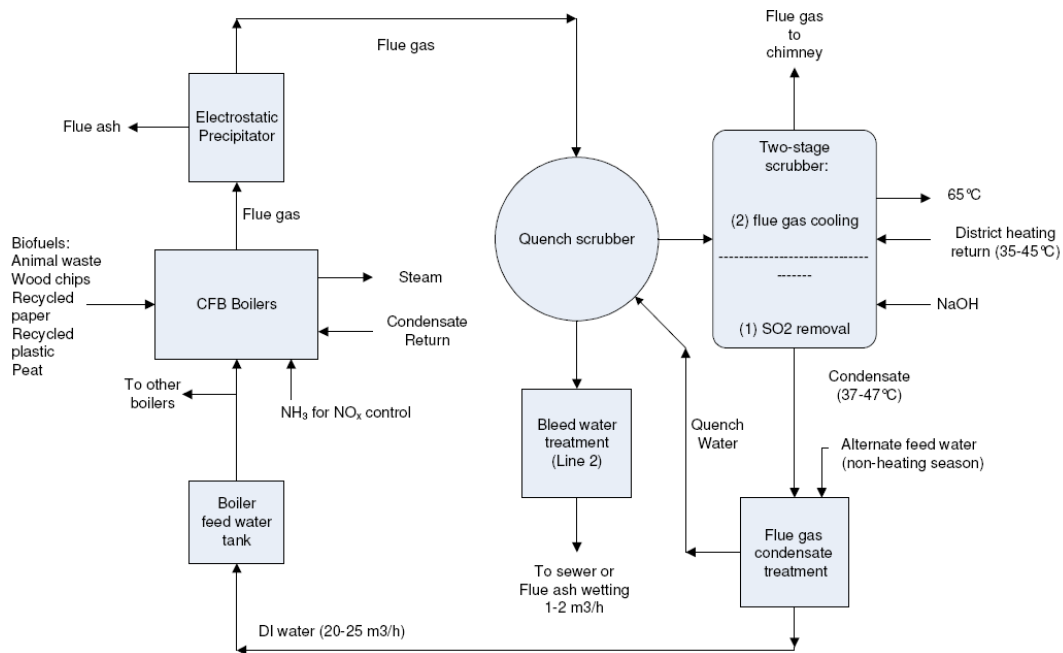

Figure 10: Illustration of a district heating boiler with flue gas condensation (ref. /25/)

► Advantages and disadvantages

The advantage of the system is that it uses a waste product and that it is regarded as CO₂ neutral. There can be a minor use of fossil fuel for e.g. transportation. The disadvantages include the high investment cost and the limited availability of the energy source. In the future, there might be a lack of biomass materials for incineration. Even if the potential energy production from biomass is large, it is also limited due to the annual growth of biomass. However, the use of biomass will contribute significantly to the renewable energy potential and it can be used in many of the existing direct heating and power plants. There are plans to develop processes for the conversion of biomass materials to wood pellets due to its advantages related to handling, shipping and storage, its large calorific value and the possibility of transporting the material long distances.

2.7. Natural gas (District heating boiler, gas-fired)

► Description of the technology

The fuel is burnt in furnaces. Heat from the flames and the exhaust gas is used to heat water (or oil) in boilers (see Figure 11). The typical heat generating capacity is between 0.5 to 20 MW. Typical modern district heating systems have supply and return temperatures of 80 °C/40°C, but supply temperatures can be up to 120 °C or even higher in pressurized systems. Plans exist to develop new district heating systems with further decreased design temperatures.

Natural gas is used for a number of applications other than district heating boilers. In the residential and service sector, it is used for space heating, heating of domestic hot water and for cooking. This fuel can also be used in centralized systems for the production of comfort cooling with absorption machines that use natural gas to create the hot steam, but it is not used for refrigeration or individual AC/ventilation systems.

In the industrial sector, natural gas is used both in individual and centralized systems. There is also a wide application for industrial process heating. Examples of operations used in the different industrial subsectors are:

- Iron and steel: heating of kilns
- Chemical industry: drying processes
- Paper industry: drying processes
- Food and beverage: drying processes
- Non-metallic mineral: heating processes

Boilers for district heating have been used for more than three decades. Nowadays, most boilers are used for peak-load or back-up capacity due to the flexibility of natural gas when there is a large peak load. The efficiencies are typically in the range of 97 – 105 % based on net calorific values.

The gross calorific value of natural gas is typically 39 MJ/m³ while the net calorific value is 10 % lower.

The difference between the net and gross calorific values is due to the water formed during the combustion of the natural gas. If the water vapour is condensed, then the heat in the water content can be exploited.

In many cases, the back-up systems are not condensing due to the additional costs (twice the expenses of non-condensing units). In many countries, the return temperature from the district heating system is high (more than 50 °C) which makes it difficult to condensate the water vapour.

► Diagram of the system

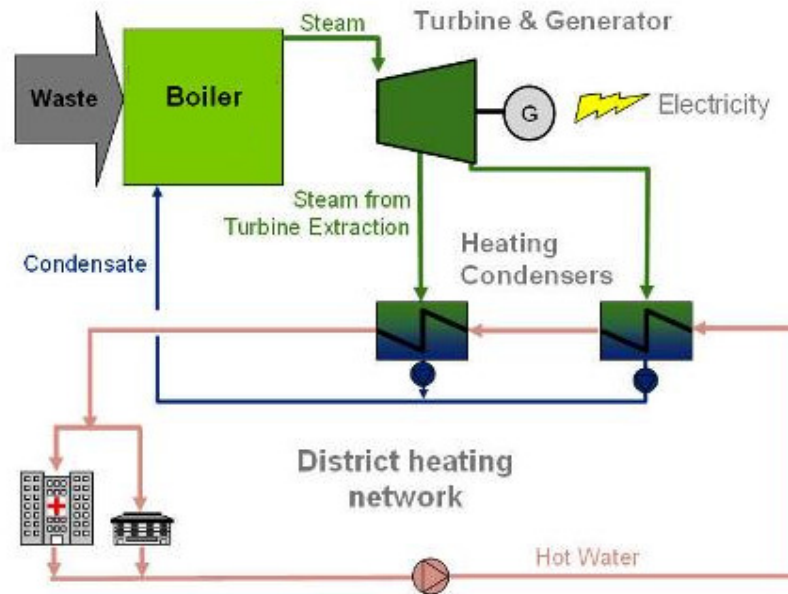

Figure 11: Illustration of district heating boiler, gas-fired (ref. /28/)

► Advantages and disadvantages

The advantage of the system is that it can produce heat relatively easily and therefore it is used for backup capacity in district heating systems in which the main part of the heat comes from other sources such as biomass. There are large distribution systems in the EU countries. The disadvantage of the technology is that it uses a fossil-based energy source, which emits CO₂ and therefore energy savings are encouraged in cases where the energy comes from natural gas.

2.8. Geothermal

► Description of the technology

Heat from underground water reservoirs can be utilized directly through a heat exchanger and used in a district heating system.

However, it is also possible and more economically feasible in many cases to use heat pumps and extract heat from reservoirs located at higher levels, which have lower temperatures than reservoirs located at deeper levels. The compressors can be either a compressor type driven by electricity or an absorption type driven by heat.

The typical system for district heating is a system with a production well, heat exchangers and/or heat pumps, transferring the heat to the district heating network and a reinjection well transferring the cooled water to the reservoir (See Figure 12). Nevertheless, it is possible to use heat from a geothermal source and then to increase the temperature of the heat by means of an absorption driven heat pump. Steam from the boilers in a district heating plant is used to drive the absorption heat pump. The boilers can use biomass or waste materials as energy source. The heat content of the steam would otherwise have been supplied directly to the district heating network at the same cost, and therefore that cost can be ignored in the economic data. In this

case, the temperature of the re-injected water can be around 8 °C and the supply temperature of the district heating system is 80 °C during winter. The specific investment cost for this system can be estimated around at 1.6 M€/MW.

Figure 13 below gives an example of a system with an absorption heat pump. The numbers in the figure indicate the energy flows relative to the extracted amount of geothermal heat, 100 energy units. Heat from the warm brine (saline water) from the reservoir is first transferred to the circulating water in the district heating system by the heat exchanger. Then, heat is extracted from the brine by the absorption heat pump and the brine is re-injected to the reservoir. The steam driven absorption heat pump increases the temperature and transfers the heat to the circulating water in the district heating system.

► Diagram of the system

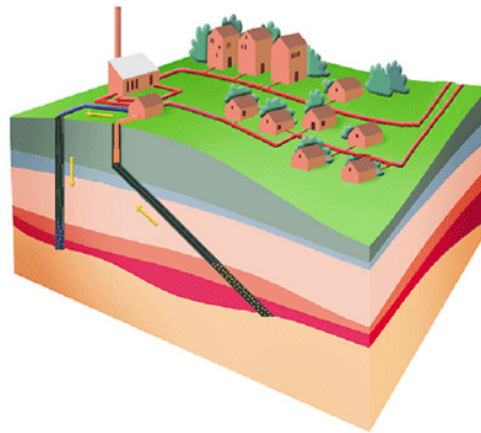

Figure 12: District heating base on geothermal sources (ref. /4/)

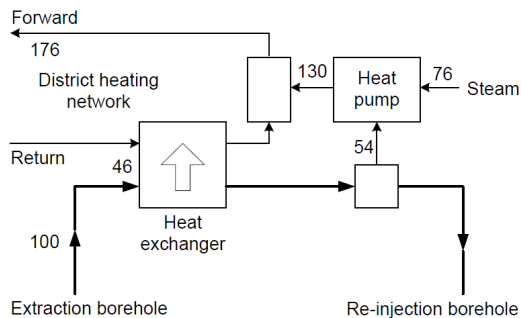

Figure 13: Illustration of a system with an absorption heat pump (Ref. /4/)

► Advantages and disadvantages

The advantage of the system is the good performance of the system and that it uses a “free” energy source with reduced CO₂ emissions. The disadvantage is the investment costs. There might also be problems due to pollutants in the geothermal water and due to clogging of the wells and there are limits to the availability of the energy source. The technique is only applicable at certain geographic locations. Some locations have available geothermal points with high temperatures while it is possible to employ heat pumps in combinations with lower ground temperatures at other locations. It is also possible to use systems where heat is stored in the ground.

2.9. Combined heat and power

► Description of technologies

Combined heat and power plants consist of four basic elements: a prime mover (engine or drive system), an electricity generator, a heat recovery system and a control system. CHP units are generally classified by the type of application, prime mover and fuel used. There are several mature CHP technologies, including reciprocating engines and turbines. Newer CHP technologies that are not yet fully commercialized, such as fuel cells and Stirling engines, are beginning to be deployed. Small-scale plants – (so called mini-CHP or micro-CHP) – can meet the needs of individual buildings or houses.

Combined heat and power is the simultaneous production of electricity and heat (for space and/or water heating), and potentially of cooling (using thermally driven chillers). CHP technologies can reduce CO₂ emissions in the building sector today in a wide range of applications, depending on the fuel chosen, its overall efficiency and the avoided CO₂ from the central electricity generating plant.

The systems described below focus on combined heat and power systems of building scale (micro-CHP or mini-CHP) with capacities from 1 kWe to 1 MWe and "campus" scale for large or several buildings with capacities from 1 MWe to 5 MWe.

Different systems can be used for the production of combined heat and power. Currently, the main types of systems used for combination of heat and power (CHP) are *reciprocating engines* in the form of spark, compression-ignited or internal combustion engines. This technology is mature and available in a wide range of sizes, with electrical efficiencies of 25 % to 48 % (typically rising according to size) and total efficiencies of 75% to 85%. *Gas turbines* use high-temperature, high-pressure hot gasses to produce electricity and heat. They can produce heat and/or steam as well as electricity, and come in the megawatt size-range. Typical electrical efficiency is 20 % to 45 %, while overall efficiencies are 75 % to 85 %. The capacity is in the MW range and therefore generally not used for normal building heating applications. *Micro turbines* are smaller versions of gas turbines typically 25 to 250 kW and therefore more suited for different types of buildings. *Fuel cells* use an electrochemical process that releases the energy stored in natural gas or hydrogen fuel to create electricity and heat. Heat is a by-product. Fuel cells that include a fuel reformer can utilize the hydrogen from any hydrocarbon fuel. Fuel cells offer the advantage of nearly one-to-one electricity-to-heat ratios, making them well suited for modern low-energy buildings. In ref. /14/ some of the possibilities and some of the characteristics are stated and they are shown in the following table.

► Advantages and disadvantages

The advantage of the system is that it produces two types of energy needs simultaneously thus providing a better total efficiency. For example, the electrical efficiency is 35 % and the heat generation gives an efficiency of 45 % thus obtaining a total efficiency of 80 %. The disadvantage is the investment costs which in the best cases ranges from about 870 M€/MW for the large-scale systems to between 1000 to 8000 M€/MW for the small-scale systems. There is not always a balance between the need for heat and power for example during summer when there might be a need for electricity for cooling but not for heating.

Table 2: Technology and cost characteristics of small and large CHP technologies in 2007

<i>Reciprocating engines</i>		
	<i>Large-scale</i>	<i>Small-scale</i>
Size range (kW _e)	100-3000	1-100
Economic life (years)	15-20	15-25
Electrical efficiency (%)	30-40	20-40
Total efficiency (%)	75-85	75-85*
Installed cost (USD/kW _e)	1 000-1 600	1 500-12 000
Fixed O&M (USD/kW/year)	1.5-10	Varies
Variable O&M (USD/kWh)	0.008-0.017	0.011-0.017
<i>Gas turbines and micro-turbines</i>		
	<i>Large-scale</i>	<i>Small-scale</i>
Size range (kW _e)	1 000-5 000	30-250
Economic life (years)	15-20	10-20
Electrical efficiency (%)	25-40	25-30
Total efficiency (%)	70-80	65-70
Installed cost (USD/kW _e)	1 050-2 000	2 000-2 700
Fixed O&M (USD/kW/year)	10-40	20-67
Variable O&M (USD/kWh)	0.004-0.005	0.011-0.017
<i>Fuel cells</i>		
	<i>Large-scale</i>	<i>Small-scale</i>
Size range (kW _e)	200-2 500	1-100
Economic life (years)	8-15	8-10
Electrical efficiency (%)	40-50	30-37
Total efficiency (%)	70-80	70-75
Installed cost (USD/kW _e)	5 000-11 000	8 000-28 000
Fixed O&M (USD/kW/year)	2.1-6.5	Varies
Variable O&M (USD/kWh)	0.03-0.04	Varies

Note: *Condensing units can have test efficiencies close to 100%.
 Sources: Discovery Insights, 2006; Japan Gas Association, 2009; Marcogaz, 2009.

2.10. District Cooling

► Description of technologies

In a district cooling system, chilled water (or brine) is produced at a central plant and distributed through the underground network of pipes to the buildings or consumers connected to the system. The chilled water is used primarily for air-conditioning systems. After passing these systems, the temperature of the water is increased and the water is returned to the central plant where the water is cooled and re-circulated through the closed loop system (see Figure 14).

A heat pump takes up energy at a lower temperature level and rejects this energy at a higher temperature level. The energy uptake in the heat pump may be very cold and can be used for cooling. In district cooling, the centrally produced cold can therefore be produced by the different types of heat pumps (chillers) described in the previous sections describing the district heating technologies. The energy source for operating the chillers can be electricity or heat in the case of absorption heat pumps. Another possibility is to apply free cooling from a heat sink such as seawater or a river. These systems can also be combined with a cold storage which most commonly is based on freezing of ice, but can also be based on other phase-changing materials.

It is also possible to use a system in connection with a district heating system where hot water is produced centrally and then distributed to a number of locally placed heat operated chillers (the

same principle as absorption heat pumps). It is possible to operate absorption chillers at temperatures as low as 85 °C. The idea is to use surplus heat produced for the district heating system, which during periods uses energy from e.g. waste materials or MSW. This technique can also be used with geothermal heat for geothermal district cooling even if it in general is poorly developed in Europe (ref. /20/). The principle is used in some cases with the geothermal heat from the region of Paris Basin (France). The combination of district cooling based on absorption chillers and district heating is especially advantageous during the summer when the needs for heating is limited to mainly domestic hot water. This type of system is expected to be competitive with other solutions as centrally based district cooling systems or locally placed electrical driven chillers.

► Diagram of the system



Figure 14: Illustration of a district cooling system (ref. /27/)

► Advantages and disadvantages

The advantage of a district cooling system is that it is possible to use less energy and emit less CO₂ compared to other alternative systems such as traditional individual systems operated by electrically driven chillers. By aggregating the need for cooling, it is possible to employ more efficient cooling technologies and optimise dimensioning than it will be possible to implement in individual buildings. The disadvantage is the investment cost, the running costs and losses in the piping system.

If absorption chillers are used in combination with district heating or if free cooling systems are used instead of electrically driven chillers it is possible not to use electricity for cooling and instead of this use a technology with limited CO₂ emissions.

3. Industrial technologies

Industrial applications might require heat and cooling, both for space conditioning and for processes. This area covers the use of heat and cold for a number of different technologies within many different industrial sub- sectors, e.g. chemicals, paper, food, refining and metals. There are several reports that describe the energy consumption in the industrial sector (ref. /16/).

This section gives an overview of the best available technologies for industrial applications.

3.1. Industrial heat processes

► Boiler technologies

▷ Description of technologies

Heating is supplied by boilers for process heating, hot water and space heating. The heat is applied for many processes such as food processing or water heating and it can be supplied at many temperatures.

▷ Diagram of the system

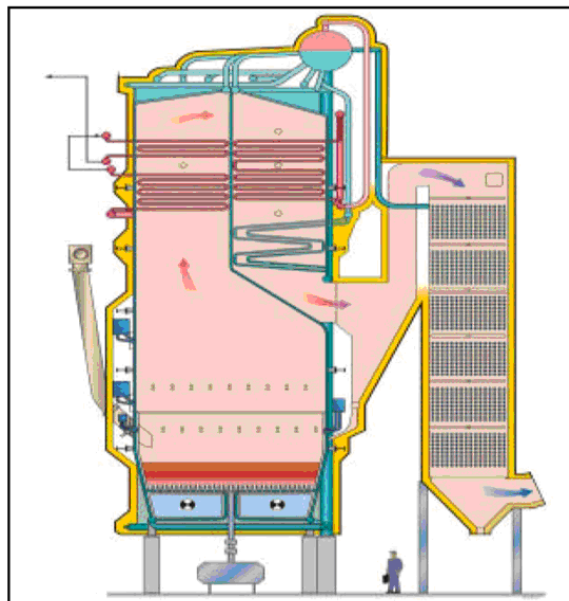

Figure 15: Example of boiler used for solid biomass and other feedstock (ref. /23/).

The fuels used in boilers are typically oil, natural gas, coal and other sources such as biomass (see Table 3).

Table 3: Most common fuel used in the industrial boilers (ref. /21/)

Fuel	Actual efficiency, full load	Actual efficiency, low load
Coal	85 %	75 %
Oil	80 %	72 %
Natural gas	75 %	70 %
Biomass	70 %	60 %

For boilers, the installation of economisers can make it possible to extract the surplus heat from the flue gas. An economiser is an equipment, which transfers heat from the flue gas to a media, which can be used for preheating of combustion air or feed water pre-heating. Mainly boilers that use natural gas can exploit this technique due to the possibility of condensation of the flue gas. In ref. /21/ it is reported that feed water pre-

heating using an economizer to extract the heat from a boiler exhaust can increase the efficiency from 1 % to 7 % (typically 5 %). Combustion air pre-heating can achieve efficiency that range between 1 % and 2 % (typically 1 %). In another analysis, it is estimated that it is possible to obtain energy savings on industrial boilers of 10 % with a 10-year payback time if a different energy saving options is used (ref. /16/).

In many cases, it is possible to replace the heat sources such as oil, coal and natural gas with alternatives as for instance renewable energy sources, e.g. biomass that is CO₂ neutral. The conversion to natural gas might be advantageous in combination with economizers, which can improve the efficiency.



Processes by temperature

- ▶ High temperature applications (above 1000 °C)

High temperatures are used for process heating e.g. within the production of iron and steel and the production of bricks and cement.

In these processes, the most common heat sources are electricity, natural gas and oil and they can be used for the process heating. Biomass boilers are also used, but this technology is more expensive. Depending on the specific biomass boiler different fuels may be used i.e. wood, straw, plastic, etc.

At least the melting temperature of iron needs to be reached when producing iron and various steel types. Therefore, temperatures in the excess of 1538 °C (melting point of iron) are necessary. In brick production the bricks are fired at temperatures reaching 900-1200 °C.

In the case of cement production, a temperature of 1400 – 1500 °C is used to form clinker from different minerals. The most common fuels used are petcoke and coal. Oil and natural gas are used to a lesser extent due to larger costs. The fossil fuels are often replaced by fuels derived from waste, e.g. wood, paper, etc. In some European countries, the replacement amounts to more than 50 % as it is show in Figure 16.

For the production of glass, temperatures can reach 1200 °C when producing fused quartz glass. However, it is possible to lower the transition temperature for the glass by adding different substances.

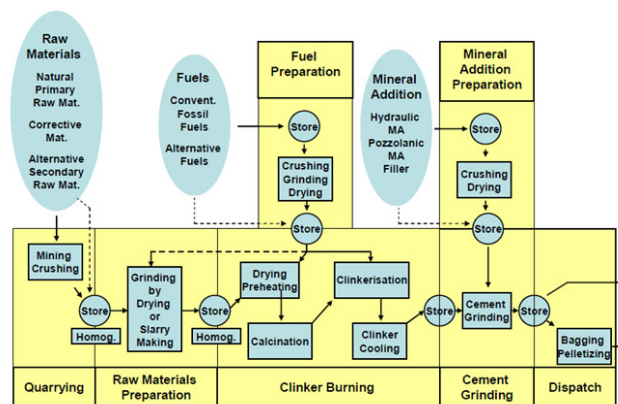

Figure 16: Simplified cement production process (ref. /22/)

The heat generated can be recuperated from the flue gases by heat exchangers and used for e.g. district heating purposes or other industrial processes using lower temperatures.

- ▶ Medium and low temperature applications (Medium: 120 – 1000°C.
Low: below 120°C)

A large number of processes in the industry utilise heat at medium and low temperatures. For example:

- Production of plastic materials: 180 – 290°C. The large temperature span is due to the different melting temperatures of the different commonly used plastic types;
- Production of plasterboards: 170°C;
- Production of bitumen and asphalt: 160°C;
- Drying technologies, e.g. some use overheated steam at temperatures 160 - 180°C.

At lower temperatures, heating and drying processes are used in many industries such as dairy, breweries, chemicals, food industry, slaughterhouses, production of paint, textile industry and the mineral oil industry.

- ▶ Optimisation of heating and drying processes

Within process heating and cooking, it is estimated that energy savings can be obtained especially by optimising the process heating by 28 % with a 10-year payback time (ref. /16/). That is done with the contribution of a number of energy saving measures, e.g. changes in the need for heat, recuperation of heat by using heat exchangers and more precise control of the processes involved.

In general, there is a large need for heating of hot process water in the food industry. Generally, the heat is produced by burning natural gas or biomass, but also to a smaller extent from electricity. The industry has a large production of low temperature waste heat giving a large potential for high-temperature heat pumps where energy is extracted and used for e.g. heating water for sterilization, cleaning or boiling. Examples of food industries where this technique is relevant are slaughterhouses, dairies and breweries.

- ▶ Heat pump technologies

In the industry, heat pumps can be used for low temperature (below 120°C) applications. The heat pumps used at this scale are mostly the same size as large heat pumps mentioned earlier.

The heat pumps are integrated in different industries to make use of waste heat from various processes and thereby improve the overall efficiency of an industrial process or a company in general.

3.2. Industrial cold processes

- ▶ Cooling technologies

Cooling is needed in some industrial processes for the production of food and for process cooling. Process cooling also covers a wide range of industries where the materials first have to be heated and then cooled. Cooling is also used in production and storage buildings.

The main types of cooling techniques are (ref. /16/):

- Mechanically driven compression cooling. (can be used for low temperatures, see principle in figure 6, uses electricity as the driving energy for the compressor);
- Cooling towers (free cooling/natural cooling, the cooling temperature depends on the ambient/wet bulb temperature, uses only electricity for circulation of water and air);
- Thermally driven cooling (absorption cooling, can be used for cooling temperatures down to 0 °C, see principle in figure 7, uses heat with relatively high temperatures (best above 120 °C) as the energy driving the process. Examples of heat sources are solar heat, waste heat from power production, geothermal heat, etc.);
- Ground water cooling (cooling temperature depends on ground water temperature). This technology is virtually CO₂ free, as only energy is consumed in the circulation pump.

When using both a mechanically driven compression cooling system and a thermally driven cooling system, there will be an amount of waste available for heating purposes. Utilizing this heat will improve the overall system efficiency.

In the area of cooling and freezing, it is estimated that it is possible to obtain energy savings by a number of optimizations. Energy savings are possible by adjusting the temperature demands (set points) for the different cooling processes, better insulation of cooling equipment, better closing of cold room doors etc.

It is possible to use alternative cooling principles (natural cooling, ground water cooling and absorption cooling). Natural cooling can be used for cooling at temperatures typically above the ambient temperatures. An example is in the plastics industry where it is used to cool down the produced products. Absorption cooling is not used very often because the heat is typically used for heating purposes instead of being used for cooling process. The assumption is that it is possible to obtain optimization of the process heating of 39 % (ref. /16/).

Heat pumps can supply both heating and cooling. Newer types of these heat pumps can provide warm temperatures of up to 90 °C and at the same time provide cold at temperatures as low as -5 °C with good efficiencies. These systems will have a large potential within the food industry, e.g. in slaughterhouses, dairies and breweries.

► Processes by temperature

▷ “Very” High temperature

Encompass cooling related to production processes of e.g. plastic. Here the cooling is necessary to speed up production and it uses typical temperatures higher than 20 °C. Cooling is typically provided by free cooling or by a heat exchanger, which can recuperate the heat for heating processes (see 3.1).

▷ High and medium temperature

The high temperature cooling uses typical temperatures in the range between 5 to 20 °C and is often used for comfort cooling. The medium temperature cooling is typical in the range between 0 to 5 °C and is used for cold rooms. High and medium temperature cooling also covers several processes in a number of industrial sectors where there is a need for cooling of products and spaces such as server rooms or production equipment. Typically, mechanical (electrical) driven compressors are used but some of the alternative technologies described above can be used in some cases.

▷ Low temperature

The low temperature cooling uses temperatures below 0 °C. The most common application is freezing and cooling of food products and rooms. Mechanically (electrical) driven compressors are used. Energy savings can be obtained by the technologies and techniques described in the chapter on combined heating and cooling.

4. Service and Residential technologies

This section gives an overview of the best available technologies employed in the service and the residential sector.

4.1. Gas (and oil) boilers

▶ Description of technologies

This section focuses on gas boilers, which are expected to have a more important part in the future compared to oil boilers, which most likely will be replaced by other heating technologies. Therefore, only limited information is provided on oil boilers.

In gas boilers, the gas is combusted and the generated flue gas passes through a heat exchanger where the warm flue gas transfers heat to another media, which normally is water (see Figure 17). The water is circulated to heat emitters in the space heating system and/or to the domestic hot water. For each part of the system, there are different design options, which can be modified in order to improve the performance. An example of such modification is the heat emitters, which can be designed with a large heat emission that provides the possibility to have low temperature supply for the heat emitters. The heat exchanger can be constructed in a way to transfer the maximum possible energy from the flue gas which allows that the water vapour in the flue gas condensates improving the efficiency. In ref. /6/ is reported that in Europe the individual central heating sector with gas fired systems in 2004 has a market share of 79%. Less than 10 % of these equipments are with condensing technology.

Gas boilers are used with many different capacities; the size of the gas boilers shown in Table 4 ranges in nominal capacities from 10 kW for small applications to 750 kW for a large sized building. The gas (and oil) distribution system is quite flexible and has relatively low installation costs per installed capacity. Because of these advantages, these systems can be combined with less flexible systems such as solar heating systems or systems, which have large installation costs per installed capacity.

Gas fired boilers are common as primary system for individual systems as well as for centralised systems, and as backup in district heating systems and renewable energy systems such as solar energy systems.

Pollutants that are emitted from the combustion process in gas- and oil-fired boilers are carbon dioxide (CO₂), nitrogen oxides (NO_x), carbon monoxide (CO) and methane (CH₄). Oil-fired burners emit the same as well as emitting sulphur oxides (SO_x), Volatile Organic Compounds (CxHy) and “soot” (Particulate Matter, PM). The ECO-design studies have concluded that the emissions of both CO and NO_x (and emissions in general) can be lowered, while remaining or improving energy efficiency (ref. /7/).

The energy mix of different countries is based on a number of political, economic, structural and historical assents. Availability of own energy resources such as hydropower, biomass and natural gas also has a large impact on the market penetration in different countries. A general European tendency is that natural gas boilers replace other individual technologies in the cities. Natural gas boilers are cheap, clean and CO₂ emissions are lower than for oil-fired or fossil solid fuel boilers.

The Ecodesign preparatory study of boilers is used to gather data on small boilers (ref. /6/, /7/, /8/, /9/). The study focused on boilers with natural gas but also supplementary solar and heat pump systems have been studied. In the study, the performance was estimated for different cases in standard buildings. The boilers have been categorized into different capacity sizes ranging from extra small (XXS) to quadruple large (4XL). The sizes 3XL and 4XL corresponds to 20 and 60 apartments, respectively.

Table 4: Load profiles – Gross heat load for various types of gas boilers

Gross Heat Load is the net heat load plus “unavoidable” losses that are inherent of the hydronic emitter system. The Gross Heat Load can be used as a secondary yardstick for the system efficiency.

Cat. Model	Net heat load (kWh/a)	unavoidable losses			Gross heat load (kWh/a)
		Stratification (kWh/a)	Distribution (kWh/a)	Other* (kWh/a)	
	Qnet	Qstrat	Qdistr	Qgen+	Qgross
XXS apartment new	2.354	175	428	370	3.327
XS average new	3.699	277	517	370	4.863
S apartment existing	4.850	295	532	370	6.047
M average existing	7.480	435	594	370	8.879
L house existing	10.515	592	635	370	12.112
XL new building (8 apartments)	20.284	1.429	2.707	978	25.398
XXL existing building (8 ap.)	42.195	2.409	3.231	1.618	49.453

*= Other relates to unavoidable generator losses (264 kWh/a), auxiliary electricity (88 kWh/s) and standby heat (18 kWh/a); For XL: 720+240+18,3=978,3; For XXL: 1200+400+18= 1618

Condensing gas boilers are considered as best available technology in the market because apart of its well establish state in the market they have only a minor possible efficiency improvements left. The steady state efficiency is 89/97, which corresponds to temperature regimes of 80/60 °C and 50 /30 °C, respectively. The temperature regime of 50/30 °C is used for condensing boilers (ref. /7/). The gas boiler has been equipped with a modulating thermostat with an electronic optimizer (a CPU for better control strategy), a high efficiency (class “A”) variable speed pump, an improved turndown ratio of 10 %, a standby loss reduced to 0.5 %, a high efficiency fan, a CPU with minimal standby power and application of a tertiary heat exchanger. These modifications have, in the study referred above, a reduction of the LCC (Life Cycle Cost) of about 30 % and a reduction of the energy consumption of about 16 % compared to a reference gas boiler.

The efficiencies of the system appear from following equation. The seasonal space heating efficiency is according to ref. /10/, calculated as:

$$\eta_s = \eta_{son} - \Sigma F(i)$$

Where:

η_s Seasonal space heating efficiency

η_{son} Seasonal steady state thermal efficiency in on-mode.

$\Sigma F(i)$ Correction factor. It is assumed to be 3.5 %.

The seasonal steady state thermal efficiency in on-mode is calculated as:

$$\eta_{son} = 0.85 \cdot \eta_1 + 0.15 \cdot \eta_4 = 0.85 \cdot 97 \% + 0.15 \cdot 89 \% = 95.8 \%$$

Furthermore, the efficiency should be corrected for the Gross Calorific Value. The ratio between Gross Calorific Value (GCV) and Net Calorific Value (NCV) is 1.11 for natural gas and 1.06 for oil.

Then the efficiency for the natural gas boiler is:

$$\eta = GCV \cdot \eta_s / NCV = GCV (\eta_{son} - \Sigma F(i)) / NCV = 1.11 (95.8 \% - 3.5 \%) = 102.5 \%$$

For a similar condensing boiler using oil the efficiency is estimated to be:

$$\eta = GCV \cdot \eta_s / NCV = GCV (\eta_{son} - \Sigma F(i)) / NCV = 1.06 (95.8 \% - 3.5 \%) = 97,8 \%$$

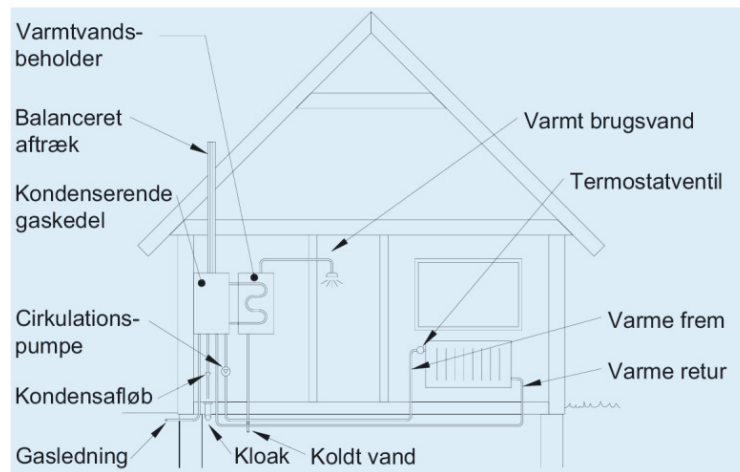

Figure 17: Illustration of a heating system with a gas boiler⁴

► Advantages and disadvantages

The advantage of the gas boiler system is that many countries have large distribution networks of natural gas and the technology is flexible. The disadvantage of the technology is that it uses a fossil-based energy source.

⁴ Varmtvandsbeholder: Storage tank for DHW, Balanceret aftræk: Exhaust from boiler ("chimney"), Cirkulationspumpe: Circulation pump, Gasledning: Supply of gas, Varmt brugsvand: Domestic hot water, Termostatventil: Thermostat on radiator, Varme frem: Heat supply, Varme retur: Heat return, Koldt vand: Cold water. Kloak: Drain- Ref /14/.

4.2. Thermal solar heating systems

► Description of technologies

Solar heating systems can be applied for heating of domestic hot water alone or combined with space heating (see Figure 19). Different types of domestic hot water systems exist. One distinction is whether it is a thermosiphon or a pumped system. A third variant is a collector integrated with the storage.

The main components are the collector which collects the solar energy, a thermal storage unit which transports the collected heat to the storage and store it for later use and finally a heat generator (a backup system) which heats the water to the requested temperature. In some parts of Europe, the generator is omitted and a sufficient temperature of the domestic hot water cannot be guaranteed.

A large number of different design options exist. Collectors can be glazed or non-glazed, flat plate or an evacuated tube (vacu-type). The flow to the collector can be of low-flow type or with pumps providing a high flow. It is assumed that the solar system is supplementary to the primary heating system, because it is most common to have a solar fraction of less than 50 % of the DHW and space heating demand. The performance is very dependent on especially the size of the solar collectors in relation to the energy consumption. This is seen as a decreasing output per m^2 of collector if the system size is increased for a specific house. The difference between the availability of solar radiation and energy demand for space heating is illustrated in Figure 18.

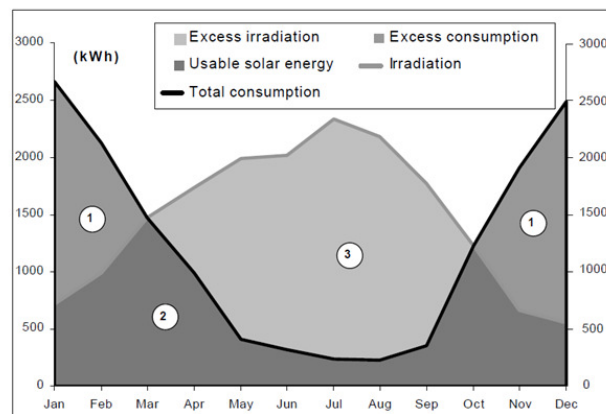

Figure 18: Figure showing an example of the annual variation in solar irradiation and energy consumption for space heating

Therefore, the energy savings are assumed to be the primary energy (for example natural gas) saved by the thermal solar heating system. It is important to mention, that besides the direct saving, there are often significant indirect savings from solar heating if the boiler can be completely shut down during the summer period, where idling losses are high. For example in Denmark the typical performance figures are $3\text{-}500 \text{ W/m}^2$ collector net energy and $600\text{-}900 \text{ kWh/m}^2$ total savings on primary energy.

Results from the Ecodesign preparatory study on boilers (ref. /9/) are used as an example. In this study a base case is defined with buildings of different sizes placed in the so-called "average EU-

25 climate" (ref. /8/). A large number of design options have been calculated in order to try to find the best available technologies (BAT). The cost is the additional cost from installing a solar heating system and integrating it with the heating and DHW system. The systems are very different in Northern and Southern Europe, the least expensive being thermosiphon systems for DHW only, typical in Greece. The most expensive will typically be the large combined DHW and space heating systems found on the German market. The BAT solar system is assumed to be of "the vacuum type" (ref. /9/) because this type of glass-tube collector offers a high performance even at low ambient temperatures. Different system sizes (areas) are used with a minimum area of 4 m². The data applied is found from the different tables in ref. /9/. As the basic cost of a solar installation is almost independent of the collector size, it is not considered economically feasible to use smaller systems. The energy savings in these examples are between 290 and 300 kWh/m². The investment costs are between 1700 and 1900 €/ (MWh · a). Another example of a solar heating system is e.g. flat plate collectors (ref. /11/). The solar systems described could be used for the renovation of a typical single-family house in Denmark. The first example is a system used for heating of domestic hot water. It has a solar collector area of 4 m² has an estimated cost around of 3330 €. The second system is used for a combined system with both domestic hot water and space heating. It has a solar collector area of 7 m² has an estimated cost around 6670 € . Both systems have energy savings of 400 kWh/m² giving investment costs of 2100 and 2400 €/ (MWh · a) for the DHW system and for the combined system.

Typical payback time for the examples above is 8-15 years. In most other EU countries, the costs will be lower per m² and the performance higher, especially in Southern Europe.

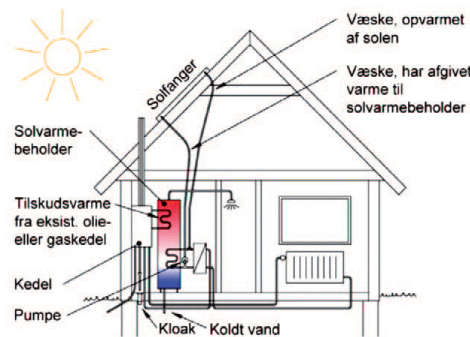

Figure 19: Illustration of a solar thermal heating system⁵

► Advantages and disadvantages

The advantage of the system is that it uses a CO₂ free energy source. The disadvantage is the investment and that the technology needs a backup energy source. The technique also depends on the availability of solar irradiation at the specific geographic location.

4.3. Comfort cooling in buildings

► Description of technology

Typically, different types of cooling systems are used; central cooling system (Figure 20), a cooling system with separate fan coils and a central chiller (Figure 21) and finally a split cooling system

⁵ Solfanger: Solar collector, Solvarmebeholder: Storage, Kedel: Boiler, Pumpe: Pump. Kloak: Drain, Koldt vand: Cold water. Ref. /14/.

(Figure 22). The split cooling system can be reversible which means it can be used as a cooling system as well as a heat pump. The systems are illustrated in the figures below.

► Diagram of technologies

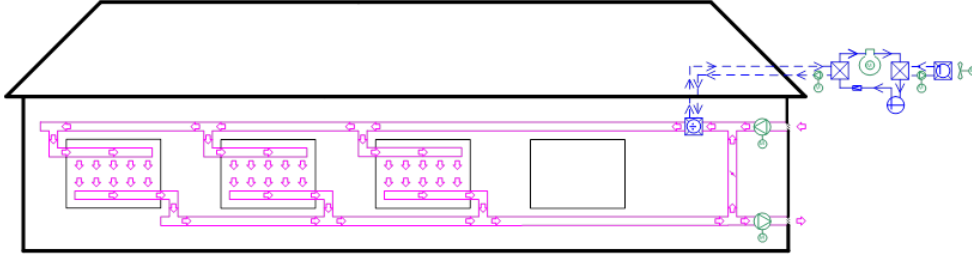

Figure 20: Central cooling system with the building being cooled through ventilation shafts.⁶

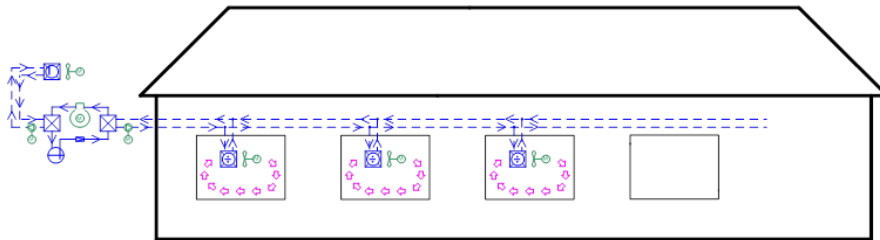

Figure 21: Central cooling system with the building being cooled through a closed water loop.⁷

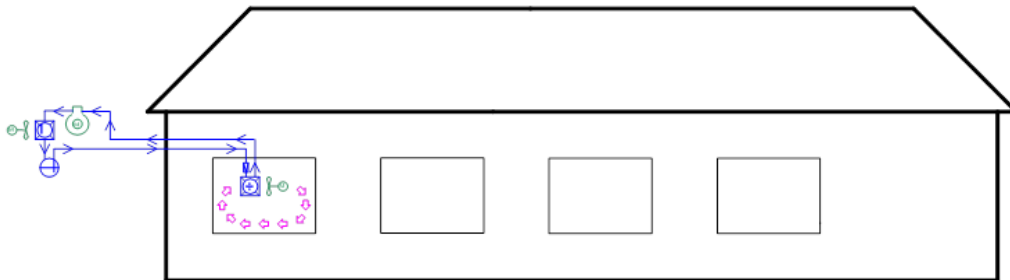

Figure 22: Split cooling system - Typical one external part and one internal part for each room

► Details about the technology

The data related to the comfort cooling in buildings is derived from the Ecodesign preparatory study Lot 10 (ref. /12/, /13/).

In the reference, different types of cooling systems are analyzed. The split cooling only and the split cooling reversible are commonly used due to the large flexibility and costs compared to the other more expensive systems. Almost all professional systems use the inverter technology because it provides a better performance. Only the “do-it-yourself” system works with the on/off

⁶ A fan coil is placed in the inlet ventilation channel of a ventilation system and hereby cooling the air. The air is then cooling the building.

⁷ Fan coils, placed inside the rooms of the building, are then cooled by the closed water circuit.

control technology. The cooling capacity and the efficiencies are shown in the table below (ref. /12/).

Table 5: Default capacity and efficiency values of base cases, (ref. /13/)

Base- cases	Cooling capacity (kW)	Heating capacity (kW)	EER	COP
Moveable	2.2		2.3	
Split cooling only	3.5		2.9	
Split cooling only	7.1		2.5	
Split reversible	3.5	4	3.1	3.4
Split reversible	7.1	8.1	2.8	3.3

Table 6: Average product price per unit for the base-cases

Base-cases	Cooling only single split	Reversible single split	Cooling only single split	Reversible single split	Single duct
	3.5kW	3.5kW	7.1kW	7.1kW	
Product prices [€]	682.5	682.5	1384.5	1384.5	389.4

Table 7: Average installation cost per unit

Base-cases	Cooling only single split	Reversible single split	Cooling only single split	Reversible single split	Single duct
	3.5kW	3.5kW	7.1kW	7.1kW	
Product prices [€]	1000	1000	1000	1000	0

The lifetime of these system is estimated around 12 years and according to prEN 15459:2006(E) the annual preventative maintenance including operation, repair and servicing costs for air conditioners typically amount to 4 % of the initial investment (including installation costs) (ref. /13/).

Comfort ventilation systems, which are integrated in larger buildings, are much more difficult to evaluate. These systems are controlled in a way, which often result in large energy consumptions when compared to the cooling needs. This occurs because in many cases comfort cooling systems are operated only for a small period of the year. There are often large stand-by losses and in many cases, the control settings can be optimized. Especially in fresh air systems, the high power consumption due to fan power needs for air transport can be reduced.

It is estimated that the cost of the cooling system alone is around 333 €/kW of cooling. For the total system including pipes and fittings the total cost is approximately 533 €/kW of cooling. These expenses are additional to a ventilation system. A cost estimate of the ventilation system is difficult due to its large variability. Two of the most influential parameters of the cost of ventilation is the size of the ventilation flow and the duct size.

► Advantages and disadvantages

In many cases, it is possible to provide a large part of the electricity used for comfort cooling from solar cells because of the large correlation that exists between the need for cooling and the solar radiation. Most split- air conditioning units are reversible and can provide heating during the winter period. The efficiency of the split system is strongly linked to the weather conditions especially to the ambient temperature. The energy efficiency of the cooling system decreases by approximately 3 % per each °C increase of the ambient temperature. The disadvantage is the investment cost (see Table 6 and Table 7) and that the technology needs electricity for the energy service. The inverter type of control is expected a reduction in the energy consumption of up to 30 % compared to the on/off control depending on the size of the system and the cooling demand.

4.4. Heat pumps

► Description

The principle of how heat pumps work is described in the section 2.4.

This section describes the most common heat pumps with hydronic central heating systems that are used for space heating and for domestic hot water (DHW) (ref. /7/). Some of the systems are reversible and can also be used for cooling purposes:

► Ground source closed loop brine/water heat pump

The most common type of ground source heat pump boiler is the vapour compression heat pumps (Figure 23). The used heat source is a horizontal collector in the soil or a vertical collector in the ground. The horizontal collector is normally placed at a depth of 0,6 to 1,5 m. Vertical collectors can have a length of up to 250 m, but typically they have a length of 100 m. Another possibility is to use ground or surface water. The temperature levels of the space heating system is typically 55/45 °C (supply and return temperatures) for existing buildings in which the existing radiators often are used. For new buildings lower temperature levels are common, e.g. 35/28 °C, which can be achieved with well-insulated buildings and the application of floor heating systems. These heat pumps are often used for both space heating and domestic hot water. They are often designed to cover 50 to 60 % of the maximum required power. These systems need a backup system, which might be electrical or fuel. However, a typical system can cover 80 to 95 % of the annual energy consumption.

The typical cost for a 8 kW system is between 10.000 and 16.000 €. The typical efficiency of this system is between 280 and 500 % for this technology (Table 8). The typical efficiency is between 290 and 340 % for heating in Northern European climates (ref. /17/). The heat collectors in the ground will have temperatures a few degrees below 0 °C during winter, which will make it possible to use the heat when the water around the collector freezes. Vertical collectors may have a benefit if ground water passes through the collector, because of the heat transfer between the collector and the passing water, which increase the temperature of the ground around the collector. If no water passes, the performance of the collector decreases after some years of operation, due to the reduction of the ground temperature around the collector.



Figure 23: Illustration of a ground source closed loop brine/water heat pump (ref. /17/)

▷ Exhaust air/water heat pump

The exhaust air/water heat pump uses a vapour compression heat pump where the heat source is the ventilation exhaust air (Figure 24). The system needs to be combined with a mechanical ventilation extraction system. This type of system is limited by the exhaust airflow and can therefore not be designed to cover more than 50 to 60 % of the maximum power for heating in the house. A parallel electric source (or another heat source) must therefore be available and used in a parallel mode. This type of heat pump is either used as a water heater or used for combined space heating and domestic hot water heating. The cost is typically between 2000 and 3500 € for a type with domestic hot water and 6000 € for a combination heat pump also covering space heating. The efficiency is comparable to other heat pump systems due to the relative high temperature of the exhaust air. In ref. /17/ is reported that for heating of the ventilation air this system in combination with an air heat exchanger the efficiency will be 310 %.



Figure 24: Illustration of an exhaust air/water heat pump (ref. /17/)

▷ Ambient air /water heat pump

This type of heat pump uses external air as a heat source (Figure 25). A drawback of air-source heat pumps is the lower efficiency that is achieved during the heating season because outside temperatures are low. Furthermore, air-source heat pumps needs a defrost cycle. If the outdoor temperature drops, near or lower the freezing temperature, the moisture of the air will condensate and freeze on the outdoor heat exchanger. The ice on the outdoor heat exchanger decreases the efficiency of the heat pump and at some point the ice must be removed by a defrost cycle. That can be done by e.g. heating the outdoor heat exchanger.

The cost typically varies between 3.000 € for a system only for space heating with no storage tank and 10.000 € for a combi system (also for DHW) with a storage tank. The typical efficiency of this system ranges from 250 to 440% for heating and cooling (Table 8) and 250 to 300 % for heating in Northern European climates (ref. /17/).

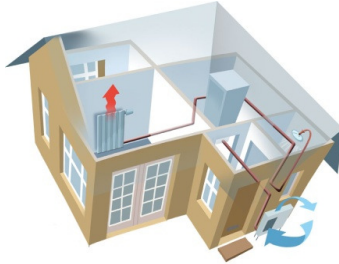

Figure 25: Illustration of an ambient air/water heat pump (Ref. /17/)

▶ Ambient air/air heat pump

The ambient air-to-air heat pumps (Figure 26) are the most utilised products on the market because they are the least expensive and they are easy to install. Regions with buildings that predominantly need cooling and only a limited amount of space heating can be served by a reversible air to air heat pump that has a cooling and a heating function. Even though the COP in heating modes of these systems drops at low temperatures (and with defrosting cycles) these systems have a high market share in Central and Northern Europe.

The typical cost is 2000 to 3000 € for a compact system excluding costs for the heat distribution system. The typical efficiency of this system is between 250 and 350 % for heating and cooling (Table 8) and typically between 260 and 340 % for heating in Northern European climates (ref. /17/).

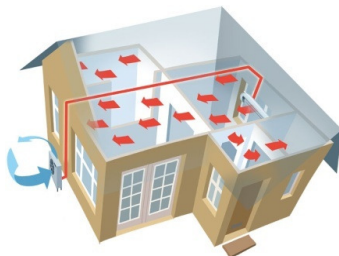

Figure 26: Illustration of an ambient air/air heat pump (ref. /17/)

▶ Advantages and disadvantages

The advantage of this heat pump system is that it uses free energy from ambient air and transforms it to a higher temperature. The disadvantage is the cost of the necessary equipment. The size of the heat pump is often designed so it needs a backup system, which might be electrical or fuel.

When comparing the different heat pump options (in cold climates) the ground source closed loop in general has a better energy performance than the ambient air based heat pumps due to the cold ambient air during mid-winter (and therefore low efficiency) and due to periodically defrosting of the evaporator. The ground source closed loop heat pump in general has larger investment costs than the ambient air based heat pump.

► Performance of heat pumps

A number of parameters influence the performance of the heat pumps. Some of the important parameters are:

- The design of the heat pump (the type of heat pump and choice of components);
- The design temperatures and the control settings of the heat emitter system;
- The climatic conditions.

Therefore, there will be large variations in generalized performance data for heat pumps. Below a table from the Technology Roadmap from IEA is presented (ref. /14/).

Table 8: Technology and cost characteristics of heat pumps for heating and cooling in single-family dwellings in 2007 (ref. /14/)

	North America	China and India	OECD Pacific	OECD Europe
Typical size (kW _{th})	2-19	1.5-4	2.2-10	2-15
Economic life (years)	15-20	15-20	8-30	7-30
Costs				
Installed cost: air-to-air (USD/kW _{th})	360-625	180-225	400-536	558-1 430
Efficiency (%)	250-450	220-350	250-650	250-350
Installed cost: ASHP (USD/kW _{th})	475-650	300-400	560-1 333	607-3 187
Efficiency (%)	250-440	250-440	250-500	250-440
Installed cost: GSHP (USD/kW _{th})	500-850	439-600	1 000-4 000	1 170-2 267
Efficiency (%)	280-500	280-500	280-500	280-500

The terminology used in the table: The types of heat pumps presented in the table are:

- “air-to-air” is an ambient air/air heat pump;
- “ASHP” is an ambient air/water heat pump;
- “GSHP” is a ground source closed brine/water heat pump.

The table shows large difference between and within the different options due to different design options and sizes.

4.5. Development of cost and performance

Table 8 shows the estimated projections for the cost and performance for some heating and cooling technologies in 2030 and 2050 (ref. /14/).

Table 9: Cost and performance goals for heating and cooling technologies, 2030 and 2050 (ref. /14/).

		2030		2050	
Active solar thermal					
Installed cost		-50% to -75%		-50% to -75%	
Maintenance cost		0% to -40%		0% to -40%	
Delivered energy cost		-50% to -60%		-50% to -65%	
Thermal energy storage PCM, thermal-chemical and centralised					
Installed cost		-50% to -75%		-65% to -85%	
Delivered energy cost		Depends on cycle regime		Depends on cycle regime	
Heat pumps					
		Space/water heating		Space/water heating	
		Cooling		Cooling	
Installed cost		-20% to -30%	-5% to -15%	-30% to -40%	-5% to -20%
Coefficient of performance		30% to 50% improvement	20% to 40% improvement	40% to 60% improvement	30% to 50% improvement
Delivered energy cost		-20% to -30%	-10% to -20%	-30% to -40%	-15% to -25%
CHP					
		Fuel cells	Microturbines	Fuel cells	Microturbines
Installed cost		-40% to -55%	-20% to -30%	-60% to -75%	-30% to -50%
Electrical efficiency		35% to 40%	30% to 35%	35% to 45%	35% to 40%
Total efficiency		75% to 80%	70% to 75%	75% to 85%	75% to 85%
Delivered energy cost		-45% to -65%	-10% to +5%	-75% to -85%	-15% to +20%

Note: Improvements in costs or performance are expressed as a percentage relative to the base year (2010) specification. However, the electrical and total efficiencies for CHP are actual percentages, not improvements. For fuel cells, the delivered energy cost is for thermal energy and is based on a long-run cost of CO₂-free hydrogen of between USD 15/GJ and USD 25/GJ in 2050.

5. Agriculture and Fishery technologies

In agriculture, a large amount of the heating is used for space heating in production facilities (stables) and greenhouses. However, apart from the cultivation of plants there is also a large need of heating for drying of the crops. In the animal husbandry, there is also a minor need for warm water for cleaning purposes. The main need is the provision of space heating in buildings.

Central heating systems are the main type used. Different sources are used; biomass, oil, natural gas and district heating. The main potential for energy savings and alternatives are related to other technologies described in Chapter 3 and Chapter 4.

Cooling in agriculture is used for refrigeration of products such as milk. The traditional mechanical compressors are the main type of technologies used. Other cooling technologies are normally not used. It might be possible to use absorption cooling in this sector.

In fisheries, cooling is needed for the production of ice, which is used for fish refrigeration. The ice is produced by mechanical compressors using electricity. The production of ice can be combined with heat generation with the use of heat pumps.

Meanwhile the consumption of energy for heat and cooling in agriculture occurs in all European countries, energy consumption in fisheries is limited mainly in the Northern and Mediterranean countries.

The production facilities and greenhouses are heated with low temperature applications and therefore it is feasible to use waste heat (e.g. from industry) or sources such as biomass. Nowadays, the most common technologies for heating are based on oil boilers, or in some cases gas boilers, due to their flexibility.

The cooling is mainly derived from traditional cooling equipment (electrically driven chillers) but other alternative technologies are also possible (e.g. absorption chillers driven by heat and combined production of heating and cooling).

Many of the heating and cooling systems correspond to the technologies described in the previous sections related to the district heating and cooling technologies (Chapter 2), industrial technologies (Chapter 3) and service and residential technologies (Chapter 4).

6. Conclusions

The present report describes different technologies which are technologically innovative techniques and economically viable and can improve the energy efficiency and reduce the CO₂ emissions in the heat and cooling market in the EU. These technologies, characterised as Best Available Technologies (BAT), are divided into several sections covering technologies for district heating including cogeneration, district cooling, industrial technologies, service and residential technologies and finally agriculture and fishery.

The technology database that has been built up to support this report contains specific techno-economic information and data per technology. Together with the heat and cooling market database it can be used in a modelling tool to analyse the role of technology innovation in the heat and cooling sector. It allows studying scenarios for the evolution of the heat and cooling demand at country level up to 2050 as well as the impacts of technology deployment on energy efficiency improvements and GHG emission reductions.

7. References

/1/ European Renewable Energy Council, 2011, Renewable Heating and Cooling. In: www.erec.org

/2/ European Commission, 2009, Directive 2009/28/EC on the Promotion of the use of energy from renewable sources.

/3/ European Commission, 2004, Directive 2004/8/EC on the promotion of cogeneration based on a useful heat demand in the internal energy market.

/4/ Danish Energy Agency and Energinet.DK. 2010. Technology Data for Energy Plants.

/5/ Energinet.dk, 2006, Solar heat storages in district heating networks. Project no. 2006-2-6750. IEE PREHEAT.

/6/ EC – DG ENER, 2007, Ecodesign preparatory study of Boilers (Lot 1), Task 2 - Market Analysis. In: <http://ecoboiler.org>

/7/ EC – DG ENER, , 2007, Ecodesign preparatory study of Boilers (Lot 1), Task 4 - Technical Analysis (incl. System Model). In: <http://ecoboiler.org>

/8/ EC – DG ENER, 2007, Ecodesign preparatory study of Boilers (Lot 1), Task 5 - Base-Case. In: <http://ecoboiler.org>

/9/ EC – DG ENER, 2007, Ecodesign preparatory study of Boilers (Lot 1), Task 6 - Design Options. In: <http://ecoboiler.org>

/10/ EC – DG ENER, 2011, Ecodesign working document communication boiler testing and calculation

/11/H. Tommerup (ed.), 2010, Energirenoveringstiltag – katalog Institut for Byggeri og anlæg, DTU Byg, Rapport R-223 (DK).

/12/ EC – DG ENER, 2009, Ecodesign preparatory study of residential room conditioning appliances (Lot 10), Task 4 - Technical Analysis. In: <http://www.ecoaircon.eu/>

/13/ EC – DG ENER, 2009, Ecodesign preparatory study of residential room conditioning appliances (Lot 10), Task 5 – Base-case. In: <http://www.ecoaircon.eu/>

/14/ OECD/IEA, 2011, Technology Roadmap, energy Efficient Buildings: Heating and cooling Equipment.

/15/ OECD/IEA, 2010, Energy Technology Perspectives, (ETP 2010). IEA, Scenarios & Strategies to 2050.

/16/ Dansk Energy Analyse A/S og Viegand & Maagøe ApS, 2010, Energibesparelser i erhvervslivet. Februar.

/17/ Dansk energi, 2011, Den lille blå om varmepumper.. www.danskenergi.dk

/18/ Videncenter for energibesparelser i bygninger, 2011, Valg af varmekilde i en- og tofamiliehuse med oliefyr Guide.

/19/ Eurostat and OECD/ IEA, 2004, Energy Statistics Manual.

/20/ EGEC. European Geothermal Energy Council, 2007, Geothermal Innovative Applications for a Sustainable Development. In: www.egec.org

/21/ ETSAP, 2010, Industrial Combustion Boilers. Energy Technology System Analysis Programme. In: www.etsap.org

/22/ ETSAP, 2010, Cement production. Energy Technology System Analysis Programme. In: www.etsap.org

/23/ Biomass for Heat and Power. Energy Technology System Analysis Programme. ETSAP. www.etsap.org. 2010.

/24/ Ref. Zander & Ingestrøm AB, 2012. In: <http://www.zeta.se>

/25/ M. Teppler, J. Wood, P. Buzzell, Flue Gas Condensate and Energy. In: www.mcilvainecompany.com

/26/ BBC, 2006, Q&A: Waste incineration. In: <http://news.bbc.co.uk>

/27/ Euroheat & Power, 2012, In: www.euroheat.org

/28/ Hitachi Zosen INOVA, 2012, Combined heat and Power. In: <http://www.hz-inova.com>

European Commission

EUR 25407 EN – Joint Research Centre – Institute for Energy and Transport

Title: **Best available technology for the heat and cooling market in the European Union**

Author(s): Forename Surname, Forename Surname, Forename Surname

Luxembourg: Publications Office of the European Union

2012 – 48 pp. – 21.0 x 29.7 cm

EUR – Scientific and Technical Research series – ISSN 1831-9424

ISBN 978-92-79-25608-0

doi: 10.2790/5813

Abstract

Every year, over 40% of the total energy consumed in Europe is used for the generation of heat for either domestic or industrial purposes whereas the cooling demand is growing exponentially. The importance of the heat and cooling sector is underlined in the EU energy policy initiatives. This emphasizes the role of technologies based on renewable energy sources combined with high-efficiency energy technologies, to meet the heat and cooling demand in Europe more sustainably in the future. In this context, the JRC led study, which was undertaken with two partners¹, to identify the current best available technologies (BATs) which can contribute to improve the energy efficiency and reduce the CO₂ emission in the heat and cooling market in the EU.

As the Commission's in-house science service, the Joint Research Centre's mission is to provide EU policies with independent, evidence-based scientific and technical support throughout the whole policy cycle.

Working in close cooperation with policy Directorates-General, the JRC addresses key societal challenges while stimulating innovation through developing new standards, methods and tools, and sharing and transferring its know-how to the Member States and international community.

Key policy areas include: environment and climate change; energy and transport; agriculture and food security; health and consumer protection; information society and digital agenda; safety and security including nuclear; all supported through a cross-cutting and multi-disciplinary approach.

