



European
Commission

JRC SCIENCE AND POLICY REPORTS

2014 JRC Ocean Energy Status Report

*Technology, market and economic
aspects of ocean energy in Europe*

Davide Magagna
Andreas Uihlein

2015

Report EUR 26983 EN

Joint
Research
Centre

EUROPEAN COMMISSION

Joint Research Centre
Institute for Energy and Transport

Contact information

Andreas Uihlein
Address: Joint Research Centre, P.O. Box 2, 1755 ZG Petten, The Netherlands
E-mail: andreas.uihlein@ec.europa.eu
Tel.: +31 224 56 5123

<https://ec.europa.eu/jrc>

LEGAL NOTICE

This publication is a Science and Policy Report by the Joint Research Centre, the European Commission's in-house science service. It aims to provide evidence-based scientific support to the European policy-making process. The scientific output expressed does not imply a policy position of the European Commission. Neither the European Commission nor any person acting on behalf of the Commission is responsible for the use which might be made of this publication.

All images © European Union 2015, except cover picture: Fotolia

JRC93521

EUR 26983 EN

ISBN 978-92-79-44611-5

ISSN 1831-9424

doi:10.2790/866387

Luxembourg: Publications Office of the European Union, 2015

© European Union, 2015

Reproduction is authorised provided the source is acknowledged.

Abstract

Oceans and seas have the potential to play a significant role in providing clean energy. Different technologies are currently being developed to ensure a long-term contribution of ocean energy to the future energy system. Among the different ocean energy technologies, tidal and wave conversion systems are expected to contribute the most to the European energy system in the short to medium term, due to both local availability of the resources and advanced technological status. Current projections foresee about 40 MW of tidal and 26 MW of wave energy capacity being installed by 2018.

The sector has witnessed encouraging signals both on the policy side and on projected markets; however, the commercialisation of key technologies and their technical maturity have not progressed as expected. In 2014, the European Commission reinforced its support and commitment to the development of ocean energy through a dedicated policy framework, and its inclusion in both the blue growth agenda and the 2050 energy agenda.

This report stems from the need to monitor the evolution of ocean energy technology, industry and market in Europe, with an eye on their global development. It aims to portray the state of play of the sector, key achievements and mechanisms in place to overcome documented gaps and barriers in the sector towards commercialisation.

2014 JRC Ocean Energy Status Report

Joint Research Centre
Institute for Energy and Transport

Davide Magagna and Andreas Uihlein

2015

TABLE OF CONTENTS

ACKNOWLEDGEMENTS	11
EXECUTIVE SUMMARY	12
1 INTRODUCTION	14
2 TIDAL ENERGY	15
2.1 Technology Status	15
2.2 Technology Developments	17
2.2.1 Floating TECs and multi-turbine platforms	17
2.2.2 Small-scale technology	18
2.2.3 Radical designs	18
2.2.4 Components and subcomponents	18
2.3 Market and European Leadership	23
2.3.1 Global developments	23
2.3.2 Aiding development and deployment	26
2.3.3 Future developments	27
2.4 Economic Aspects and Cost Components	28
2.4.1 CAPEX and cost components	29
2.4.2 Future power ratings	29
2.4.3 LCOE predictions	29
3 WAVE ENERGY	31
3.1 Technology Status	31
3.2 Technology Developments	33
3.2.1 Small-scale devices	33
3.2.2 Increased collaboration	33
3.2.3 Components and subcomponents	33
3.3 Market and European Leadership	36
3.3.1 Global development	36
3.3.2 Aiding development and deployment	38
3.3.3 Future development	41
3.4 Economic Aspects and Cost Components	42
3.4.1 CAPEX and cost components	42
3.4.2 Future power ratings	43
3.4.3 LCOE predictions	43
4 OVERVIEW OF EMERGING TECHNOLOGIES	44
4.1 Ocean Thermal Energy Conversion	44
4.1.1 Technology development and status	45
4.1.2 Technical challenges and current research	45
4.1.3 Economic and market aspects	47
4.2 Salinity Gradient	48
4.2.1 Technology development and status	49
4.2.2 Technical challenges and current research	50
4.2.3 Economic and market aspects	50

5	ACTIONS AND CHALLENGES	53
5.1	Identifying Priorities and Actions	53
5.2	Technology and Resources	54
5.3	Finance	57
5.4	Environmental and Administrative Issues	60
5.5	Grid Availability and Integration: A Joint Approach	61
6	KEY FINDINGS AND CONCLUSIONS	63
7	REFERENCES	64

LIST OF FIGURES

Fig. 1	Distribution of R&D efforts in tidal technology types	16
Fig. 2	Structural layout of a typical section of a composite laminate tidal blade	19
Fig. 3	Drivetrain options for tidal energy converters	20
Fig. 4	Control systems currently employed in TEC	21
Fig. 5	Ocean energy supply chain breakdown in France	23
Fig. 6	Distribution of tidal companies in the world	23
Fig. 7	Tidal energy network	25
Fig. 8	Electricity generation from tidal energy converters in the UK	25
Fig. 9	European tidal deployment 2012–2014	26
Fig. 10	Expected tidal developments until 2018	27
Fig. 11	CAPEX breakdown for tidal power	29
Fig. 12	LCOE predictions for tidal arrays	30
Fig. 13	Distribution of R&D efforts according to wave energy technology type	32
Fig. 14	Main material employed for WEC prime mover	34
Fig. 15	Wave energy applications	34
Fig. 16	Installation of WECs	34
Fig. 17	Wave energy conversion methods in electricity	35
Fig. 18	PTO employed in wave energy conversion	35
Fig. 19	Distribution of wave companies in the world	36
Fig. 20	Wave energy network	38
Fig. 21	Wave infrastructure in Europe	39
Fig. 22	Expected wave developments until 2018	41
Fig. 23	CAPEX breakdown for wave power	42
Fig. 24	LCOE predictions for wave arrays	43
Fig. 25	OTEC resources: Temperature difference between 30 m and 1000 m depth	44
Fig. 26	Simplified open-cycle OTEC process flow diagram	44
Fig. 27	Simplified closed-cycle OTEC process flow diagram	45
Fig. 28	Heat exchanger test facility at NELHA	45
Fig. 29	Disaggregated CAPEX for a 10 MW OTEC plant	47
Fig. 30	Salinity gradient resources: Salinity at surface level	49
Fig. 31	Simplified RED process flow diagram	49
Fig. 32	Simplified PRO process flow diagram	49
Fig. 33	Statkraft's PRO pilot plant in Tofte, Norway	50
Fig. 34	RED pilot plant at Afsluitdijk, Netherlands	50
Fig. 35	TRL of ocean energy technologies	54
Fig. 36	Key recommendations from the SI Ocean Wave and Tidal Strategic Technology Agenda	55

Fig. 37	LCOE for alternative and conventional energy technologies	57
Fig. 38	Total RD&D investment in wave and tidal energy projects in 2011 in m EUR	57
Fig. 39	Support mechanisms according to market maturity and deployment level	59
Fig. 40	Synergies between wave and tidal and offshore wind cost components	62

LIST OF TABLES

Table 1	Tidal energy device classification	16
Table 2	Examples of upscaling of HATs by leading tidal energy developers	17
Table 3	Overview of developer–manufacturer collaboration for composite tidal blade design	20
Table 4	Descriptions of most common generators for tidal energy applications	21
Table 5	Components comparison for the MeyGen project	22
Table 6	Identified suppliers for TECs	22
Table 7	Shortlist of tidal developers identified by JRC	24
Table 8	EU and national schemes to facilitate deployment of tidal energy arrays	27
Table 9	Leased tidal energy projects in Europe	28
Table 10	Techno-economic data for tidal energy	29
Table 11	Wave energy converters classification	32
Table 12	Wave energy systems and related PTO	35
Table 13	Identified suppliers for WECs according to component and service	36
Table 14	Shortlist of wave developers identified by JRC	37
Table 15	Wave energy development and deployment projects receiving EU or national support. Australian and US flagship projects are also included	40
Table 16	Upcoming wave energy demonstration projects	41
Table 17	Techno-economic data for wave energy	43
Table 18	Planned and proposed OTEC projects worldwide	46
Table 19	Cost estimates for OTEC plants: CAPEX and LCOE	47
Table 20	Overview of main players in the OTEC sector	48
Table 21	Cost estimates for salinity gradient plants: CAPEX and LCOE	51
Table 22	Overview of some players in the salinity gradient sector	52
Table 23	Concerted activities and actions to overcome ocean energy technical challenges	56
Table 24	Ocean energy technology challenges and research focus areas	56
Table 25	Current market push and pull mechanisms for ocean energy from EU Member States	58
Table 26	Current market push and pull mechanisms for ocean energy from the EU	58
Table 27	Current market push and pull mechanisms for ocean energy from non-EU countries	59
Table 28	Review of consenting processes across EU Member States located in the Atlantic Arc	60

ACRONYMS AND ABBREVIATIONS

AEL	Aviation Enterprise Limited
AEP	Annual Energy Production
AMETS	Atlantic Marine Energy Test Site
ARENA	Australian Renewable Energy Agency
BIMEP	Biscay Marine Energy Platform
BNEF	Bloomberg New Energy Finance
CAPEX	Capital Expenditure
CF	Capacity Factor
CRI	Commercial Readiness Index
DDG	Direct-Drive Generator
DECC	Department of Energy and Climate Change (UK)
DFIG	Double-Fed Induction Generator
EC	European Commission
EII	European Industrial Initiative
EMEC	European Marine Energy Centre
ENR	Syndicat des Énergies Renouvelables
ENTSO-E	European Network of Transmission System Operators for Electricity
ETRI	Energy Technology Reference Indicator
EVE	Ente Vasco de la Energía
EWEA	European Wind Energy Association
FRP	Fibre-Reinforced Plastic
HAT	Horizontal-Axis Turbine
IEC	International Electrotechnical Commission
IEE	Intelligent Energy Europe
IP	Intellectual Property
IRENA	International Renewable Energy Agency
JRC	Joint Research Centre
KPI	Key Performance Indicator
LCOE	Levelised Cost Of Energy
MCT	Marine Current Turbine
MEAD	Marine Energy Array Demonstrator
MRCF	Marine Renewables Commercialisation Fund
MSFD	Marine Strategy Framework Directive
NER 300	Funding programme, financed from the New Entrants' Reserve of the EU emissions trading scheme
NREAP	National Renewable Energy Action Plan
OEM	Original Equipment Manufacturer
OPEX	Operating Expenditure
OPT	Ocean Power Technologies

OTEC	Ocean Thermal Energy Conversion
OWC	Oscillating Water Column
OWSC	Oscillating Wave Surge Converter
PLOCAN	Oceanic Platform of the Canary Islands
PMSG	Permanent Magnet Synchronous Generator
PRO	Pressure-Retarded Osmosis
PTO	Power Take-Off
R&D	Research and Development
RD&D	Research, Development and Demonstration
RED	Reverse Electrodialysis
REN	Redes Energéticas Nacionais
RES	Renewable Energy Source
SCIG	Squirrel-Cage Induction Generator
SEIA	Sustainable Energy Authority of Ireland
SETIS	Strategic Energy Technologies Information System
TEC	Tidal Energy Converter
TRL	Technology Readiness Level
TSB	Technology Strategy Board
TSL	Tidal Stream Ltd
TSO	Transmission System Operator
US DOE	US Department Of Energy
WEC	Wave Energy Converter
WRIG	Wound-Rotor Induction Generator
WRSG	Wound-Rotor Synchronous Generator

ACKNOWLEDGEMENTS

The authors would like to thank the following internal and external experts, who reviewed the draft report and contributed their ideas to its improvement: Anne Marie O'Hagan from University College Cork, Jose Luis Villate from Tecnia and Oliver Wragg from EMEC. We also thank our colleagues Matthijs Soede from DG RTD, and Thomas Barbas and Evangelos Tzimas from DG JRC for their valuable input.

EXECUTIVE SUMMARY

The ocean energy sector comprises different energy technologies that could exploit the power contained in our seas, and convert it into renewable low-carbon electricity. The various types of ocean energy technologies, such as tidal energy, wave energy, ocean thermal energy conversion and salinity gradient energy, have reached different stages of technical and commercial development, in Europe and globally.

Given their geographical distribution and the wealth of resources available in Europe, tidal and wave energy are those poised to provide the most significant contribution to the European energy system. Ocean thermal energy conversion and salinity gradient technologies are emerging technologies, which have gained attention and support from original equipment manufacturers and policy makers, despite being at an early stage of development.

Globally, the ocean energy sector is continuously growing. Increased interest in developing and commercialising ocean energy technologies is seen in different areas: from the EU, who launched the Ocean Energy Forum in April 2014 to ensure a coherent integrated approach to overcoming existing barriers, to Chile and Australia, who are supporting the sector with ad-hoc grants and incentives, to increased interest and ongoing deployments in Eastern Asia, and to intense hubs of research in Canada and the USA. Ocean energy has reached the stage at which technology developers must prove that they can reduce the costs of their technology whilst increasing the reliability and performances of the devices in order to tap into a potentially large market.

The picture is very different and disparate among the various technologies and policy contexts. The ocean energy market is developing at different paces, with a number of tidal technologies closing towards the development and deployment of early arrays, wave energy projects continuing to pre-commercial demonstration, and ocean thermal energy conversion and salinity gradient technologies developing first-of-a-kind installations.

Overall, ocean energy deployments are taking place at a slower pace than expected. According to the targets set in 2009 in the different EU National Renewable Energy Action Plans, a combined tidal and wave energy capacity of 2250 MW was expected by 2020. However, taking into account ongoing projects, by 2018 only about 40 MW of tidal and 26 MW of wave energy capacity will be deployed. An encouraging sign in this context is the deployment of the first tidal array project, expected in 2016 in the United Kingdom. Wave energy technologies

are lagging behind tidal energy, but a number of deployment projects are progressing in Europe, the US and Australia at present. Ocean thermal energy conversion and salinity gradient technologies are developing demonstration plants: a 10 MW ocean thermal energy conversion plant will be built in Martinique, whilst a 50 kW salinity gradient pilot plant began operation in the Netherlands. The EU is at the forefront of technology development, with more than 50 % of tidal energy and about 45 % of wave energy developers being located in the EU. The majority of ocean energy infrastructure, such as ocean energy test centres, is also hosted in the EU.

Ocean energy technologies face four main bottlenecks: technology development, finance and markets, environmental and administrative issues, and grid issues.

Technological barriers represent the most important challenge that the ocean energy sector needs to address in the short-medium term. Technology development is paramount for the growth of the sector and for the establishment of an ocean energy market in Europe and globally. Developing reliable technology is therefore fundamental to ensure the establishment and growth of the ocean energy market. Fundamental, in this context, would be the establishment of standards and parameters for assessing the success and progress of the technologies, such as performance targets and key performance indicators for each ocean energy technology type. Overcoming technology issues is key to provoking solutions to the additional barriers hindering the sector's development, in particular financial hurdles.

Due to high capital demands for first arrays, securing investment is one of the main barriers the sector currently faces. Ocean energy technology is yet to become commercially viable, thus public financial support is crucial for its development. Support mechanisms need to be implemented in view of the market maturity of the technology. It is therefore key to ensure that support mechanisms are matched to the actual status of the technology and with specific technology needs, as seen in other sectors. Leading tidal energy technologies have reached the stage where market push mechanisms could help their uptake and the establishment of a market; whilst for other ocean technologies, development needs to be supported with technology push mechanisms.

The potential environmental impacts of ocean energy projects continue to be documented but are not yet definitive due to the early stage of devel-

opment of the technology. Scrutiny by regulatory authorities and licensing issues are some of the main bottlenecks for ocean energy deployments. Recommendations for overcoming these issues include the optimisation of consenting procedures, their harmonisation across the different Member States and common monitoring requirements for ocean energy. Test centres and EU-wide research programmes can play an important role in studying and assessing the potential environmental impacts of ocean energy.

Ocean energy projects often require grid upgrades or new installations due to the fact that areas in Europe with high ocean energy resource potential are remote and not connected to the existing electricity grid. Integration of renewable electricity will depend to a large extent on the development of the European grid and the implementation of the 2030 framework for climate and energy policies, since development or upgrading of grid infrastructure will be needed in order to reach the new climate targets.

Renewable energy sources stakeholders and developers should ensure that renewable electricity in remote locations is taken into account and that the needed grid upgrades are implemented in a timely manner.

Public interventions thus far proposed appear to be adequate to sustain the growth of the sector; though it is essential they can accommodate the differences among the various technologies, and their statuses. Continued concerted efforts and the harmonisation of policy at EU level are expected to help the sector to overcome administrative and environmental issues; whilst the shift towards a more integrated European energy system may help alleviate infrastructural issues such as grid availability. A number of initiatives funded through the EU, IEA and research councils seek to identify solutions, to overcome recognised barriers to commercialisation of ocean energy. This will help stimulate research, development and demonstration, and policy initiatives further, for the overall benefit of the sector.

1 INTRODUCTION

Oceans and seas have the potential to play a significant role in providing clean energy, containing vast amounts of energy that can be harvested in many forms: by exploiting the power contained in waves, the streams of tides and ocean currents, or the temperature and salinity gradients in the water.

Different technologies are currently being developed to ensure the long-term contribution of ocean energy to the future energy system and to decarbonisation targets. Whilst ocean energy could provide a considerable share of the European and global low-carbon energy mix, the short-term forecast for the sector is very modest, due to the nascent status of the technologies and to a series of technical, environmental and financial barriers that hinder both development and market uptake.

In Europe, the highest deployment potential can be found along the Atlantic coast, with further localised exploitable potential in the Baltic and Mediterranean seas and in the outermost regions (e.g. Reunion, Curacao). Eight EU countries have included ocean energy in their National Renewable Energy Action Plans (NREAPs) – the UK, Ireland, France, Portugal, Spain, Finland, Italy and the Netherlands (SWD(2014)13 2014a). Developing and delivering ocean energy could therefore play a threefold role for Europe: contributing to the decarbonisation of energy supply; increasing energy security by exploiting indigenous resources; and fuelling economic growth in the coastal regions.

Among the different ocean energy technologies, tidal and wave conversion systems are expected to contribute the most to the European energy system in the short to medium term (2025–2030), due to both local availability of the resources and advanced technological status. Salinity gradient and ocean thermal energy conversion (OTEC) have not reached the same level of maturity, and small-scale prototypes are currently being deployed in different locations.

The sector has witnessed encouraging signals both on the policy side and on projected markets; however, the commercialisation of key technologies and their technical maturity have not progressed as expected, prompting an increased need for technology developers to deliver reliable, survivable and affordable technologies in the short term to ensure the growth of the sector. In 2014, the European Commission (EC) reinforced its support and commitment to the development of ocean energy through a dedicated policy framework and its inclusion in both the blue growth agenda and the 2050 energy agenda (COM(2012) 494 final 2012; COM(2014) 8 final 2014).

This report stems from the need to monitor the evolution of ocean energy technology, industry and markets in Europe, with a view to their global development. The report is based on the research and policy-support work that the Joint Research Centre (JRC) has undertaken over the last few years, and aims to portray the state of play of the sector, key achievements, and mechanisms that have been put in place to overcome documented gaps and barriers to commercialisation of the sector.

The scope of this report is thus to provide, within the framework of present and future European policy scenarios, an overview of the activities and progress made by the ocean energy sector. The report comprises sections addressing specific technologies: an overview of tidal energy technology is provided in Chapter 2, investigating the technology status, how the tidal market is shaping up, cost prediction and possible bottlenecks. Similarly, Chapter 3 addresses the development and deployment of wave energy converters (WECs). Chapter 4 presents an overview of emerging ocean energy technologies, such as OTEC and salinity gradient, highlighting recent progress on the technological side and the potential developments for European industries and the energy sector. Chapter 5 presents an overview of barriers and challenges hindering the progress of the sector, highlighting particular activities and initiatives aimed at overcoming them.

2 TECHNOLOGY STATUS AND DEVELOPMENT

Tidal energy technology comprises a cluster of different technologies that exploit tidal cycles to generate renewable electricity, including tidal barrages, tidal lagoons, tidal stream devices and dynamic tidal power. More specifically, tidal barrages consist of dam-like structures that use the differences in potential energy between a land-based reservoir and sea level, generated by the tidal flow, to generate electricity. Tidal lagoons are based on the same concept; however, in this instance the reservoir is an independent enclosure in a highly tidal environment. Tidal stream devices use the water currents generated by tidal motions, thus using turbines to exploit the kinetic energy contained in the water flow. Dynamic tidal power exploits the difference in water level created by an open-dam structure built perpendicular to the coast to drive bidirectional turbines.

Tidal energy technologies have the advantage of being highly predictable and could therefore provide a stable output to the grid, compared to other ocean energy technologies and renewable energy sources.

In terms of technological maturity, tidal barrages represent the most advanced type of tidal technology and currently comprise most of the ocean energy capacity installed worldwide. The 240 MW La Rance tidal barrage, located in the north-west of France, has been operational since 1966; whilst in 2011, the 254 MW Sihwa tidal plant started operating in South Korea, with a further 2680 MW in the pipeline up to 2017 (Ernst & Young 2013). In the UK, a proposed tidal barrage project (the Severn barrage) has been rejected on multiple occasions, due to the potential environmental effects that such a structure could have on the nearby ecosystem and the unclear economic benefits that the project could provide (House of Commons 2013). As such, despite the technology being ready and bankable, it is unlikely that further tidal barrages will be created in Europe in the near future.

Tidal lagoons offer minimised environmental impact, since the reservoirs are built directly in the sea, and could thus find wider applications. The estimated global potential for tidal lagoons is 80 GW. Projects to develop six tidal pools off the south coast of Wales (UK) have received positive feedback in economic, energy and life-cycle terms (Cebr 2014).

The biggest untapped potential for tidal energy is represented by tidal stream devices, with the potential for a significant market share in future energy systems. However, compared to lagoon and barrage technologies, tidal energy converters (TECs) have yet

to reach the same level of technical and commercial maturity, a required condition for becoming a reliable and affordable energy option. Market signals are encouraging enough to expect tidal stream technologies to move towards pre-commercial and commercial arrays within the next ten years, despite a series of setbacks that may slow the progress in the short term.

In Europe, the most powerful tidal stream resources are located in France, Ireland, Norway and the UK, with localised tidal zones in Belgium, Italy and the Netherlands. Since tidal stream represents the group of tidal devices that can grow the most in the near future, as well as providing the highest contribution in terms of energy to the European energy system, only tidal stream technologies will be considered further in the report.

2.1 Technology Status

A variety of designs have been developed in order to harness the kinetic energy available in tidal streams. Turbine designs based on those developed by the wind industry represent the most common type of tidal technologies; however, as the industry evolves, new types of technologies are being developed. Several classification systems of tidal energy converters have been developed. Following recent reviews of the sector by the EU co-funded SI Ocean project and the International Renewable Energy Agency (IRENA) (SI Ocean 2013a, IRENA 2014a), the classification developed by the European Marine Energy Centre (EMEC) is used in this report (Table 1). Further classifications of TEC could be defined according to the type of foundations or mooring employed and on operational conditions of the device. Whilst the conversion systems affect the primary energy conversion and efficiency of the device in ideal conditions, assessing the type of foundation and operational conditions provides further information on the potential installation and operational costs of the technology.

At present, horizontal-axis turbines represent the most common type of tidal device. A JRC report (Corsatea & Magagna 2013), which looked at innovation activity within the ocean energy sector, estimated that currently horizontal-axis turbine devices account for 76 % of research and development (R&D) efforts in the development of tidal devices worldwide (Figure 1).

Table 1: Tidal energy device classification

Device type	Class	Description
Horizontal-Axis Turbine	A	Similarly to wind energy converters, this technology exploits the lift from the tidal flow to force the rotation of the turbine mounted on a horizontal axis. This operates a rotor, converting mechanical energy to electrical energy through use of a generator.
Vertical-Axis Turbine	B	The principle of operation of vertical axis turbines is similar to the horizontal devices, except the turbines are mounted on a vertical axis.
Oscillating Hydrofoil (Reciprocating Device)	C	Oscillating hydrofoils comprise a hydrofoil located at the end of a swing arm, which is allowed to oscillate in pitching mode by a control system. The motion is then used to pump hydraulic fluid through a motor. The rotational motion that results can be converted to electricity through a generator.
Ducted Turbine or Enclosed Tips	D	Enclosed tips (ducted) turbines are essentially horizontal-axis turbines contained within a Venturi duct. This is designed to accelerate and concentrate the fluid flow. Ducted structures could also reduce turbulence around the turbines and facilitate the alignment of water flow towards the turbines.
Archimedes' Screw	E	These devices are a variation of the on vertical-axis turbines, drawing power from the tidal stream as the water flows up through the helix.
Tidal Kite	F	Tidal kite devices comprise a tethered kite with a small turbine. The kite effectively flies through the flow, increasing the relative flow velocity entering the turbine.
Other	G	Novel tidal concepts currently under development that do not fit any of the above categories.

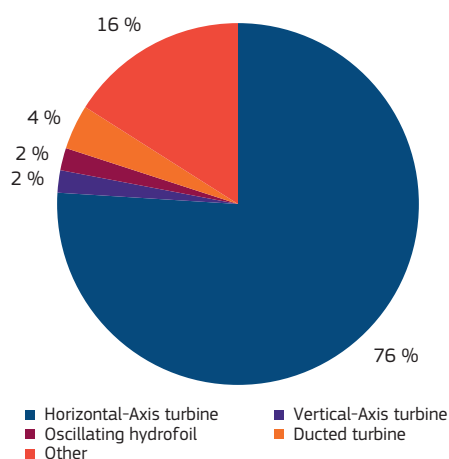

Fig. 1: Distribution of R&D efforts in tidal technology types. Source: Corsatea & Magagna 2013

The evolution of tidal devices shows that first-generation tidal devices were designed for bottom-mounted installations (Carbon Trust 2011; SI Ocean 2013a). Second-generation devices, floating TECs, are designed to exploit the most powerful resources in the mid/high water column, whilst third-generation devices are looking to exploit additional tidal resources within the water column (e.g. tidal kite, Archimedes' screw). As previously mentioned, the operational conditions and the type of foundations play a significant role with respect to performance and cost of the technologies.

Tidal devices can be installed on fixed structure, such as monopiles, pods and gravity foundations, or floating and moored to the seabed by tethers. Whilst a convergence can be seen in the type of tidal technology, the same cannot be said with regards to foundations: about 40 % of tidal devices require floating connections, and 60 % require fixed foundations (IRENA 2014b). Foundations have been identified as an area where industrial collaboration could minimise costs and reduce installation and maintenance time.

Horizontal-axis turbines (HATs) not only represent the most common type of TEC, but they form the class of device that has sustained intensive open-water testing and shows high technology readiness levels (TRLs). In the UK alone, one of the key players in ocean energy development, more than 11000 MWh of electricity generated by ocean energy were fed to the grid since 2008, with 10500 MWh of them being generated by horizontal-axis tidal devices (Ofgem 2014).

The Seagen tidal converter, developed by Marine Current Turbines/Siemens (MCT), has been operational in Northern Ireland since 2008 and accounts for over 9200 MWh fed to the grid. Other examples are the Alstom/TGL Deep Gen and the Andritz Hydro/Hammerfest HS1000, which have generated over 1300 MWh in the last two years. All three companies have a track record in upscaling their devices to full commercial scale, and they have attracted investment from key original equipment manufacturers (OEMs), such as Siemens, who acquired MCT in 2011. Similarly, Alstom has acquired TGL from RollsRoyce, whilst Andritz Hydro has acquired Hammerfest (Table 2). A similar progression was seen when French OEM DCNS acquired about 60 % of Irish developers OpenHydro (DCNS 2014a). Siemens has recently announced divesting its ownership of MCT; implications on the tidal sector and market are addressed in Section 2.3.3.

The technology progression seen by tidal energy converters has brought other key industrial players to the sector, notably Voith Hydro, Kawasaki Heavy Industries, Hyundai Heavy Industries, Tocardo and Schottel, to mention a few, which are involved in either technology development or adaptation of existing conversion technologies to second- and third-generation tidal structures.

Table 2: Examples of upscaling of HATs by leading tidal energy developers

Developer	1 st Prototype	Year	2 nd Prototype	Year
MCT/Siemens	300 kW	2003	2x 600 kW ^a	2008
Alstom/TGL	500 kW	2011	1200 kW	2013
Hammerfest/Andritz Hydro	300 kW	2009	1100 kW	2013
Open Hydro/DCNS	200 kW	2008	2200 kW	2012
Voith Hydro	110 kW	2012	1000 kW	2013

^a The MCT Seagen device was first deployed with only 1 rotor and then with 2 rotors.

2.2 Technology Developments

The tidal sector is continuously developing, with industry leaders focussed on deploying pre-commercial arrays, whilst novel designs and innovative solutions are being examined to ensure that the full potential available is exploited and costs reduced. Different trends can be seen in the sector (SI Ocean 2013a):

- Floating TECs and multi-turbine platforms
- Small-scale technology
- Radical designs
- Components and subcomponents

2.2.1 Floating TECs and multi-turbine platforms

The evolution from first- to second-generation tidal devices is seen mainly in the development of floating TECs (SI Ocean 2013a). First-generation turbines, based on the successful design of conventional wind turbines, were designed to be mounted on the seabed by a monopile, a pinned structure or gravity structure. First-generation tidal devices have sustained a wealth of testing in operational conditions and achieved significant energy production in the UK. One of the disadvantages of first-generation turbines is the high cost associated with their foundations, coupled with the potential environmental impacts that their installation may have on marine life. Second-generation TECs consist of floating structures, such as the Scotrenewable SRTT device, Ocean Flow Energy Evopod and Nautricity Cormat turbine. The advantages of these technologies can be multiple:

- Exploiting more powerful resources: since tidal stream velocity is higher at the water surface, floating TECs can make use of more favourable resources, obtaining higher efficiencies and conversion rates.
- Devices can be floated in position; thus the costs for installation, retrieval and maintenance can be further reduced, resulting ultimately in a lower levelised cost of energy (LCOE).
- Buoyancy allows for multiple devices to be supported on the same platform, reducing the torque on foundations/moorings that the platform has to bear.

At the current stage, floating TECs have not reached similar levels of reliability and production as first-generation devices, and will soon be required to prove their technologies at full scale.

The development of floating TECs has also opened the way to the development of multi-rotor platforms. Initial devices were designed to be technology neutral, allowing integration of both horizontal- and vertical-axis turbines. However, as technology design is progressing towards prototype testing in real water, it can be seen that most advanced designs make use of horizontal-axis turbines. The Scotrenewable SRTT 250 kW device is designed to support two contrarotating two-bladed horizontal rotors. Bluewater announced the deployment in the Netherlands, in collaboration with Tocardo, of a 200 kW device, and is also developing a two-rotor 2 MW tidal floating turbine (called BlueTEC) jointly with MCT/Siemens (Bluewater 2014). BlueTEC will consist of two three-bladed HATs from MCT, whilst Bluewater is in charge of the design of the floating platform. Both companies have announced plans for a commercial development in Canada, and have obtained a lease for a site in the Bay of Fundy (MCT 2014). The Nautricity's Cormat turbine employs two contrarotating three-bladed rotors on the same axis. Tidal Stream Ltd (TSL) and Sustainable Marine Energy are both developing multi-rotor platforms and have announced partnerships with Schottel to use its SG50 50 kW three-bladed turbine.

TSL is developing different versions of the Triton submerged platform. The Triton S is designed to accommodate between 20 and 60 SG 50 kW rotors for an overall nominal power of 1–3 MW and can operate in water depths of 25–40 m. The Triton 3 and Triton 6 platforms are expected to accommodate three and six 2 MW third-party turbines, respectively; however, at the current stage, no announcement has been made on the turbine developer.

Sustainable Marine Energy has been developing the PLAT-O flexible platform for a number of years, and whilst the initial design comprised five ducted turbines, they have recently announced the development of a PLAT-O 100 device comprising two SG 50 kW rotors (Schottel 2014). The company has recently received further funds to deploy its device

in UK waters following further testing of their platform (ReNews 2014a).

The development of floating TECs and of multi-rotor platforms is showing promising signs in terms of international and industrial collaboration, which may accelerate the uptake of floating technologies.

2.2.2 Small-scale technology

A number of tidal developers are developing small-scale technologies in order to reduce both costs and risks that are associated with testing and deployment of the devices. This represents a strong shift in a sector that has long focussed on developing devices with a nominal capacity of > 1–2 MW. As pointed out in the SI Ocean Gaps and Barriers Report (MacGillivray *et al.* 2013), large devices are essential to ensure that ocean energy targets are met and potentially in creating a market for ocean energy; however, developing and deploying small-scale devices could aid the learning curve of the sector.

Different companies are currently developing and deploying small-sized tidal turbines. Tocardo B.V., a Dutch company, has been developing its rotor blade design for about ten years, and deployed the T1 device in Den Over in 2008. The T1 is a 100 kW two-bladed rotor, designed to operate at tidal speeds of about 2 m/s. The small size of the device allows for installation in shallow tidal sites and in rivers. The company is already commercialising its T1 and T2 devices, and is now looking into developing a 500kW turbine for installation in Scottish waters, and is collaborating with Airborne Group for the development and mass manufacturing of its composite blades.

Nova Innovation has recently deployed its Nova 30 in Shetland, a 30 kW three-bladed rotor, employing a Siemens generator and gearbox. The device has been labelled as the first micro-scale tidal generator, as well as being the first community-owned tidal device to become operational. The company is currently looking at the development of a 100 kW model and has received further funds to develop a 500 kW array in the Shetland Isles (Business Green 2014).

Schottel GmbH, a German company specialising in developing marine propellers, has developed a 50 kW three-bladed rotor. The company previously provided shaft, hub and pitch mechanisms employed in the development of the Andritz/Hammerfest Strøm AS1000 device (Maritime Executive 2014). The STG50, like the T100, presents no-pitch mechanisms and is designed for application on multi-tidal platforms. Schottel focussed on minimising the weight of the rotor: a whole STG50 weighs about 800 kg (Schottel 2013). The weight of a 1 MW array composed of 20 STG50 devices is therefore 16 t, whilst the average weight of a nacelle of a conventional 1 MW turbine is 130 t (Andritz 2014);

such a reduction may prove essential in reducing the capital expenditure (CAPEX) associated with the manufacture of tidal devices. The next step for small-scale developers is to demonstrate that their technologies are cost-efficient and ensure reliable operation in waters.

2.2.3 Radical designs

In the past few years, developers have looked into novel and alternative ways to harness tidal flow, especially looking at exploiting deep-water flows and/or slower tidal flows. Of the many concepts developed, two devices are showing substantial development and deployment activities: Flumill and Minesto's Deep Green.

Flumill, a Norwegian company, has developed a double-helix tidal device based on excess-flow valves from the gas industry. The two screws rotate in opposite directions, providing further hydrodynamic stability to the device, and activate a gearless permanent magnet generator. The company has tested a quarter-scale device at EMEC. The development of a 2 MW tidal plant is currently underway in Rystraumen in Norway. The company has already managed to secure permits for installation and 73 % of the funds to finance the 20 m EUR project, with 40 % of the funds coming from ENOVA (Trayner 2014).

The Swedish company Minesto is developing the Deep Green tidal kite, designed to operate in water depths of 60–120 m and at tidal velocities > 1.5 m/s (Minesto 2014a). The device consists of an 8–14 m-wide kite and 3–5.5 m-long nacelle, equipped with an enclosed turbine and a gearless generator. The water current generates a lift on the kite, forcing the turbine to move. The company is currently operating a quarter-scale device in Strangford Lough in Northern Ireland. It has received further funds from the Department of Energy and Climate Change (DECC) in the UK to continue the development of its turbine, and has been awarded a seabed lease for the development of a 10 MW plant in Wales (Minesto 2014b; Minesto 2014c).

2.2.4 Components and subcomponents

The general structure of tidal energy converters comprises a prime mover (blades, sails, helixes or foils), a foundation/mooring system and a generator, which may be coupled with a gearbox. In the case of a tidal kite, the nacelle is attached beneath the kite. In the most common horizontal-axis turbines, blades are connected to the hub, and the nacelle incorporates the generator, the gearbox, the control mechanisms and the converter to ensure that the energy generated can be fed to the grid. Whilst the tidal sector exhibits a certain level of design consensus, the picture looks slightly different when components and subcomponents of TECs are taken into account.

2.2.4.1 Blades

Blades are a critical component of tidal energy converters, and their structural stability is of primary importance in ensuring the overall reliability of a device. As pointed out in Davies *et al.* 2013, at the current stage of development of tidal turbines, much information concerning tidal turbine blades is highly confidential, especially with regards to shape and detailed information on the materials used.

Fifty percent of horizontal-axis turbine designs currently being developed use three-bladed turbines, while 25 % use a two-bladed rotor. Other designs may use four, six or more blades. As witnessed in the wind energy sector, it is likely that the three-blade rotor offers a higher stability to the device. Recent reports and press releases indicate that MCT/Siemens are also developing a three-bladed turbine, marking a significant step change from the long-tested two-blade system, tested in Northern Ireland.

Different materials have been employed so far in the manufacturing of blades/prime movers for tidal energy converters, from pinewood to glass-reinforced resins, carbon fibres and composite materials. The development and design of composite HAT blades follows closely those of wind turbine blades, with steel and fibreglass initially employed by developers, but now moving towards the use of infused quasi-unidirectional glass/epoxy mixes or carbon fibres/prepreg resins (Bir & Migliore 2004; Akram 2010; Davies *et al.* 2013). As highlighted in Bir *et al.* 2011, different materials can be employed in different parts of the blade, with a composite box spar running through the mid-section of the blade to provide strength and increased resistance for load-bearing (Figure 2).

Funds have been directed towards R&D on blades and composite materials, which can help both increase the reliability of the devices and reduce the manufacturing costs of the blades. For example, The Carbon Trust and the Technology Strategy Board (TSB) have signed a Memorandum of Understanding with Aviation Enterprise Limited (AEL) to optimise the development of lightweight carbon fibre blades, resulting in the development of third-generation prepreg materials ensuring higher resistance and reduced manufacturing time (AEL 2014). As highlighted both in Bir *et al.* 2011 and Davies *et al.* 2013, the use of composite materials allows tidal developers to collaborate directly with blade manufacturers to optimise design and import important knowledge from aviation and wind energy engineering. Examples of these collaborations can be found in Table 3.

2.2.4.2 Foundations and moorings

Along with the development of tidal converters, developers have looked at different ways to install devices on the seabed. Foundations and moorings need to provide support to loads during operation and allow easy access to the devices in case of maintenance. The type of foundations adopted for a particular tidal device depends on structural stability, the type of seabed and the water depth at the location. Monopile foundations, as used for offshore wind turbines, are a simple, robust and proven technology; however, they are limited in terms of water depth and show high installation costs.

The high cost associated with pile-type foundations led to the development of gravity-based and pinned structures. Gravity foundations are normally favoured in low-sediment seabed, whilst pinned

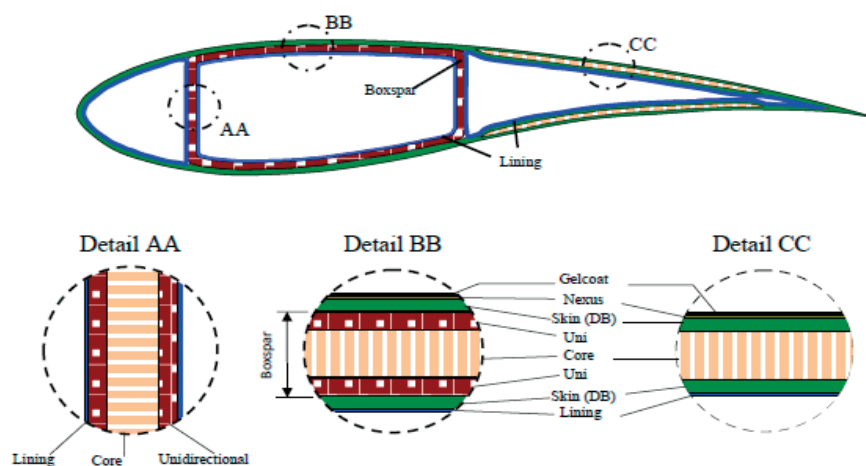

Fig. 2: Structural layout of a typical section of a composite laminate tidal blade. Source: Bir *et al.* 2011

Table 1: Overview of selected drilling methods

Tidal Developer	Blade Manufacturer	Website
Marine Current Turbines/Siemens	AEL	www.aviationenterprises.co.uk
Alstom/TGL	AEL	www.aviationenterprises.co.uk
Tocado	Airborne Marine	airborne-marine.com/
Andritz Hydro/Hammerfest	Gurit	www.gurit.com/
Atlantis	Norco Ltd	www.norco.co.uk
OpenHydro/DCNS	Norco Ltd	www.norco.co.uk
Schottel	Avantgarde Technologie	www.avantgardetechnologie.de/
Pulse Tidal	Designcraft	www.designcraft.co.uk/
Tidal Energy Ltd	Designcraft	www.designcraft.co.uk/
Ocean Flow	Designcraft	www.designcraft.co.uk/
Scotrenewables	Designcraft	www.designcraft.co.uk/
TidalStream	Designcraft	www.designcraft.co.uk/

systems employ piles to maintain the position of the support structure. In both cases the device is connected to a tripod or tetrapod structure. Developers such as Atlantis, Andritz/Hammerfest, OpenHydro, Nova Innovations, Alstom/TGL and TidalStream have all developed tripod structures for the installation of their turbines. Voith Hydro and Verdant employ a single-pod gravity structure, whilst Siemens/MCT is moving towards a tetrapod structure to host its new turbines. About 60 % of tidal developers are currently investigating different types of foundations, whilst the remaining ones are developing floating converters that will be moored. Tethered systems employ anchors and plates to ensure seakeeping of devices (IRENA 2014b).

2.2.4.3 Generators, control, gearboxes, power converters

The drivetrain is composed of a series of components that are needed to assure the conversion into electricity and its feasibility in the grid: generators, control systems, gearboxes, transformers and converters. Depending on the type and size of the TEC and on the chosen configuration, few or all of these components may be employed (Figure 3).

One of the most important features of tidal energy converters is ultimately the generator, allowing the mechanical energy to be converted into electrical energy. In this area, tidal energy has closely followed

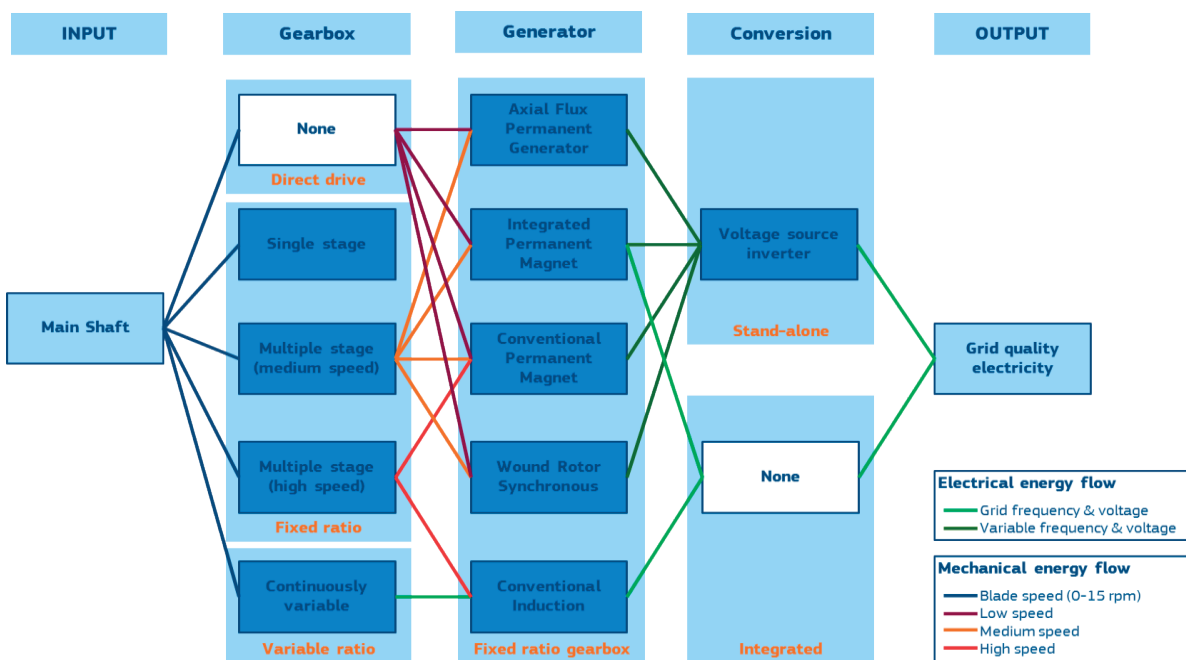

Fig. 3: Drivetrain options for tidal energy converters. Source: Bower 2013

the steps of wind energy, whose evolution may offer an account of future progression for the tidal sector. Different generator configurations are available to ensure the TEC can feed into the electrical grid.

Generators employ electromagnetic induction, from the relative motion of a magnet against a stator, which varies with the type of excitation system used, the type of magnet and the phase of the system. Synchronous generators include the wound-rotor synchronous generator (WRSYG) and the more common permanent magnet synchronous generator (PMSG). Direct-drive generators (DDG) (or linear generators) are a type of PMSG that may not require the use of a gearbox. In recent years, the wind industry has seen an increase in the introduction of asynchronous or induction generators that could offer a more attractive solution for marine energy applications, since they are able to absorb power fluctuations (Lynn 2013; Lacal Arántegui 2014). The most important asynchronous generators are the squirrel-cage induction generator (SCIG), wound-rotor induction generator (WRIG) and double-fed induction generator (DFIG). Lynn (2013) and Elghali *et al.* (2007) have reviewed the most common types of generators for ocean energy applications, as summarised in Table 4.

A review of existing leading and innovative tidal devices shows that 45 % employ gearless PMSGs whilst 50 % use a combination of gearbox and generator (IRENA 2014b). Different control systems are, however, employed; many turbines (30 %) employ pitch regulation, an active system that adjusts the inclination of blades in the flow to reduce torque, whilst others use stall regulation (10 %), a passive system in which the speed of the turbine is reduced in high flows. Whilst reducing the need of active control, stall systems require the blades to be designed so that the turbine slows down at very

high velocity. Other designs use overspeed regulation (15 %), by which the turbine adopts passive adaptive blades and keeps its rotational speed constant. Other control systems force the turbines to be moved away from the current (yaw and tilt control); in other cases no control system is implemented on the turbines. Many developers have not yet disclosed the type of control system employed on their devices. An overview of the control systems used in TECs is provided in Figure 4.

Gearboxes, power converters and brake systems are mechanisms that have been well developed for other applications, such as hydropower, wind power and conventional power systems, and are being adapted to tidal conditions. Developers are continuously engaging with different companies to develop and/or adapt subcomponents to suit their devices and to increase reliability. The MeyGen project, which may become the first commercial tidal array, provides an overview of the main differences in terms of compo-

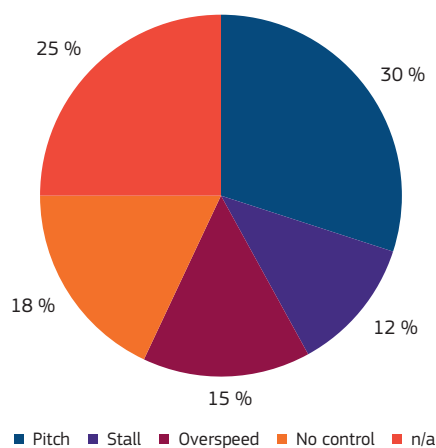

Fig. 4: Control systems currently employed in TEC. Source: JRC 2014

Table 4: Descriptions of most common generators for tidal energy applications

Type	Advantages	Disadvantages
Squirrel-Cage Induction Generator	<ul style="list-style-type: none"> • Wide speed range • Reactive and active power control system • Widely proven technology 	<ul style="list-style-type: none"> • Requires gearbox • Full-scale power converter
Wound-Rotor Synchronous Generator	<ul style="list-style-type: none"> • Wide speed range • Reactive and active power control system • May not require gears 	<ul style="list-style-type: none"> • Multipole generator • Full-scale power converter • Small-sized converter for field
Permanent Magnet Synchronous Generator	<ul style="list-style-type: none"> • Wide speed range • May not require gears • Reactive and active power control system • Low maintenance • Does not require power converter for field 	<ul style="list-style-type: none"> • Requires permanent magnets • Multipole generator • Full-scale power converter
Direct-Drive Generator	<ul style="list-style-type: none"> • Additional mechanical simplicity 	<ul style="list-style-type: none"> • Need of sophisticated power control system (uneven generator)
Double-Fed Induction Generator	<ul style="list-style-type: none"> • Limited speed range (± 30 % of synchronous speed) • Inexpensive inverter • Full control of reactive and active power 	<ul style="list-style-type: none"> • Requires gears • Requires slip rings

Source: Elghali *et al.* 2007; Lynn 2013

nents between the two types of turbine that will be installed in the first stage of the project: the Atlantis AR1500 and the Hammerfest/Andritz HS1000 Mk1 (Table 5).

The continuous progression of tidal energy towards commercialisation requires that components and subcomponents be fully tested to ensure the reliability of components. MacGillivray *et al.* report that many of the failures experienced so far by ocean energy devices relate to small components, which would require one person to fix (MacGillivray *et al.* 2013), whilst wind energy experience shows that frequent failures are attributed to power electronics and gearboxes, with gearbox failure causing greatest downtime (Sheng 2013).

The development of a supply chain is essential for the delivery of a commercially viable tidal energy

sector. The tidal industry is engaging widely with subcomponent manufacturers, either to design ad-hoc components to fit on their devices or to use off-the-shelf components (Table 6). Pullen *et al.* (2009) have found that wind energy manufacturers seek a balance of outsourcing of components and in-house development. These trends have developed unique market structures for each subcomponent development.

Table 6 provides information on how the tidal energy supply chain is shaping up in terms of specific components and subcomponents. It is possible to notice, as in the case of blade components, that many developers share common suppliers. A correct estimate of the number of companies involved at any stage of the tidal energy supply chain is currently not possible, as many companies have announced developments in a particular area of the sector

Table 5: Components comparison for the MeyGen project

Component	Atlantis AR1500	Andritz HS1000
Rated power	1.5 MW	1.5 MW
Rotor diameter	18 m	18 m
Inspection period	6.25 years	5 years
Blade material	Glass-reinforced plastic	Carbon steel
Generator	PMSG	Induction
Pitch system	Collective hydraulic	Independent electrical
Gearbox	2-stage	3-stage
Cable connection	Wet-mate	Dry-mate

Source: MeyGen 2014a; Tethys 2014a

Table 6: Identified suppliers for TECs

Developer	Bearings	Brakes	Shaft	Gearbox	Control	Generator	Electrical
Alstom/TGL			Invo-tech	Orbital2 Wikov		In-house	
Andritz Hydro/ Hammerfest			Schottel			In-house	Converteam
Atlantis R.C.		Altra Industrial Motions	Schottel	David Brown	Schottel	ATB Morley	ABB
Nova Innovation				Siemens		Siemens	
Ocean Flow		James Fisher Defence	James Fisher Defence	James Fisher Defence			
OpenHydro						In-house	
Pulse Tidal		Bosch Rexroth	Bosch Rexroth	Bosch Rexroth	Fraunhofer IWES	In-house	Senenergy Econnect
Schottel	Wolfgang Preinfalk					In-house	
Scotrenewables					MacArtney	In-house	ABB
MCT/Siemens	NKE		Invo-tech	Orbital2 Wikov		In-house	
Tidal Energy Limited				Siemens		In-house	General Electrics

Source: Information retrieved from company sites. Tenders may have changed following testing of components/R&D advancements.

but not disclosed the developer/s they are working with. From an overview of participants at international conferences and exhibitions on ocean energy, such as the Tidal Energy Summit, Thethys EMR and All-Energy, it is possible to estimate that over 500 companies in Europe are involved in any one stage of the development of ocean energy. A breakdown of the composition of the supply chain, based on data from Syndicat des Énergies Renouvelables (ENR), shows how 170 companies form the ocean energy industry in France (Figure 5).

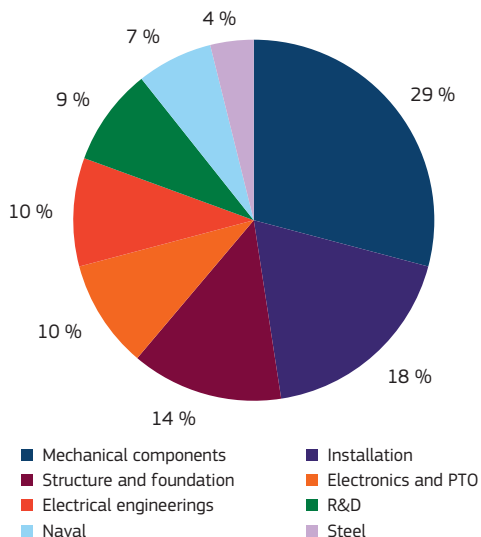

Fig. 5: Ocean energy supply chain breakdown in France. Source: ENR 2014

As the sector expands and the tidal market picks up, it is likely that the supply chain will consolidate itself, allowing for a clear overview of the industrial entities involved in the industry.

2.3 Market and European Leadership

2.3.1 Global developments

A large number of developers have worked and are still working on developing tidal energy technology; an estimate provided by EMEC identifies 100 tidal

energy companies worldwide (EMEC 2014a). It is likely that the total number will increase in the future. More than 50% of tidal developers are located in the EU, which currently represents the hub of tidal energy development. Countries such as Canada, Australia and the USA also have strong representations, whilst increased activities are seen in eastern Asia (Figure 6).

The level of technological maturity that each technology has reached differs from developer to developer. Table 7 presents a shortlist of tidal energy developers that have either tested their devices in open waters or are aiming to in the near future, and are looking into the development of pre-commercial or small commercial arrays. Such a selection allows an understanding of how the sector is currently shaping up; however, it does not allow the prediction and forecasting of whether selected technologies will reach full commercialisation. The International Renewable Energy Agency (IRENA) has proposed a more detailed shortlisting of tidal developers, taking into account among other factors company history, development and deployment strategies, and external validation (highlighted in Table 7). Similarly, IRENA stresses that this approach allows an understanding of various aspects of development, but not whether a particular technology will become a cost-effective way to convert tidal energy into electricity.

Figure 7 provides a view of the locations of leading tidal energy developers. It highlights how Europe, and in particular resource-rich countries such as the UK, France and Norway, are investing in tidal technologies, and shows that the sector is also fostering the interest of industrial companies with long histories in developing hydropower but located in non-tidal areas.

Despite industrial interest, the sector has not been able to fully exploit its momentum in meeting deployment targets. Like the whole ocean energy sector, the tidal industry has reduced its deployment forecasts for 2020. Market uptake does not correspond to the targets set in the National Renewable

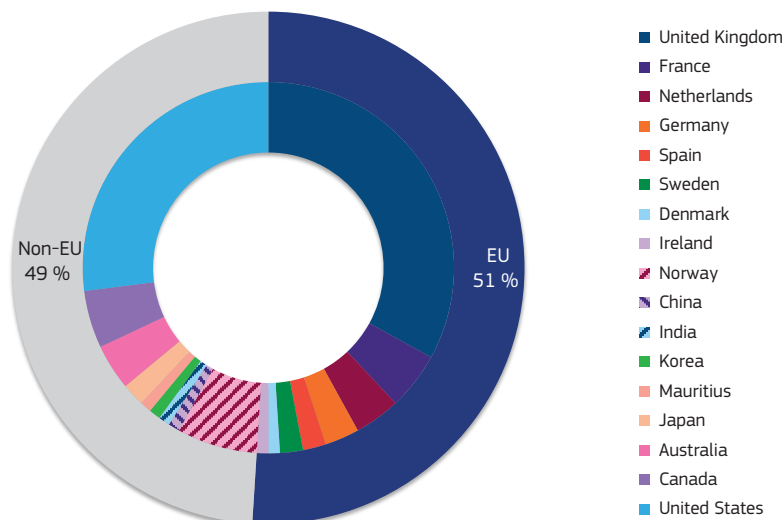

Fig. 6: Distribution of tidal companies in the world. Source: EMEC 2014a

Table 7: Shortlist of tidal developers identified by JRC

Company Name	Model	Operational Testing	Country	Website
Alstom Hydro/Tidal Generation Limited	TGL series	Full-scale	France/UK	www.alstom.com/power/renewables/ocean-energy/tidal-energy
Andritz Hydro Hammerfest	HS series	Full-scale	Norway/Austria	www.hammerfeststrom.com
Aqua Energy Solutions	AES tidal devices	Part-scale	Norway	www.aquaenergy.no
Atlantis Resources Corporation	AN series, AR series, AS series	Full-scale	Singapore/UK	www.atlantisresourcesltd.com
BioPower System Pty Ltd	bioStream	Full-scale	Australia	www.biopowersystems.com
Bluewater	BlueTEC	Part-scale	Netherlands	www.bluewater.com/new-energy/tidal-energy/
Clean Current Power Systems	Clean Current Turbine	Full-scale	Canada	www.cleancurrent.com
Deepwater Energy BV	Oryon Watermill	Part-scale	Netherlands	www.deepwater-energy.com
EEL Energy	EEL Tidal Energy Converter	Small-scale	France	www.eel-energy.fr/en
Elemental Energy Technologies	SeaUrchin	Small-scale	Australia	www.eetmarine.com
Flumill	Flumill	Part-scale	Norway	www.flumill.com
Hydra Tidal Straum AS	Hydra tidal	Part-scale	Norway	www.hydratidal.info
Hyundai Heavy Industries		Part-scale	South Korea	www.hyundaiheavy.com/news/view?idx=332
IHC Tidal Energy/ Tocado ^a	OceanMill	Part-scale	Netherlands	www.ihctidalenergy.com
Kawasaki Heavy Industries Ltd		Full-scale	South Korea	www.khi.co.jp/english/news/detail/20111019_1
Marine Current Turbines	SeaFlow, SeaGen	Full-scale	UK/Germany	www.marineturbines.com
Magallanes Renovables	Atir	Part-scale	Spain	www.magallanesrenovables.com
Minesto	Deep Green	Part-scale	Sweden	www.minesto.com
Nautricity	CoRMaT	Full-scale	UK	www.nautricity.com
New Energy Corporation	EnCurrent Turbine		Canada	www.newenergycorp.ca
Nova Innovation	Nova-I	Part-scale	UK	www.novainnovation.co.uk
Ocean Flow Energy	Evopod	Small-scale	UK	www.oceanflowenergy.com
Ocean Renewable Power Company	TidGen	Small-scale	USA	www.orpc.co
Oceana Energy Company	Oceana	Small-scale	USA	www.oceanaenergy.com
OpenHydro (DCNS)	Open Centre Turbine	Full-scale	Ireland/France	www.openhydro.com
Sabella SAS	Sabella D03	Part-scale	France	www.sabella.fr
Schottel Group	STG series	Full-scale	Germany	www.schottel.de
Scotrenewables	SR series	Part-scale	UK	www.scotrenewables.com
Tidal Energy Ltd	DeltaStream	Part-scale	UK	www.tidalenergyltd.com
TidalStream Limited	Plat-O	Part-scale	UK	www.tidalstream.co.uk
Tidalys	Electrimar1800, 4200	Part-scale	France	www.tidalys.com
Tocado Tidal Turbines	T series	Full-scale	Netherlands	www.tocado.com
Uppsala University: The Ångström Laboratory		Small-scale	Sweden	
Verdant Power	Free Flow System	Full-scale	USA	www.verdantpower.com
Voith Hydro	HyTide	Full-scale	Germany	www.voith.com/en/products-services/hydro-power-377.html
Vortex Hydro Energy	VIVACE	Small-scale	USA	www.vortexhydroenergy.com

^a Tocado acquired IHC Tidal in November 2014

■ Companies shortlisted by IRENA



Fig. 7: Tidal energy network. Purple markers: developers' headquarters; red markers: test sites and demonstration sites under development

Energy Action Plans (NREAPs), which foresaw the combined tidal and wave energy capacity reaching 2253 MW in 2020 (SWD(2014)13 2014b).

In the last two years, Bloomberg New Energy Finance (BNEF) has revised the projected tidal deployment targets for 2020 to 167 MW (2013) and 148 MW (2014) (BNEF 2014). It shall be noted that BNEF forecasts are based on the assessment of announced projects, their financials and the technological status of the selected technology. Forecasts could therefore be boosted in the near future if the sector proves it can deliver affordable electricity to the grid.

A number of tidal technologies have reached advanced TRLs (> TRL 6)¹ and a number of technologies are in open-water test phase. The majority of deployments have so far taken place at EMEC. It was the first ad-hoc wave and tidal test centre opened in 2003, and other centres and locations have followed recently. Leading technologies have already fed significant amounts of electricity to the grid, and thus commenced the development of pre-commercial and first-of-a-kind commercial arrays. In total, up to February 2014, 10 500 MWh were generated by certified tidal developers in the UK (Figure 8), which represents a significant achievement for the industry.

From the data publicly available, it can be seen that existing technologies have achieved high capacity factors of up to 56 %, with average values greater than 25 %: in the range of reference values for R&D projects and close to those experienced by offshore wind. It has to be noted that capacity factors have been calculated on a monthly basis and do not take into account any eventual or planned shut-off of the device during testing phase.²

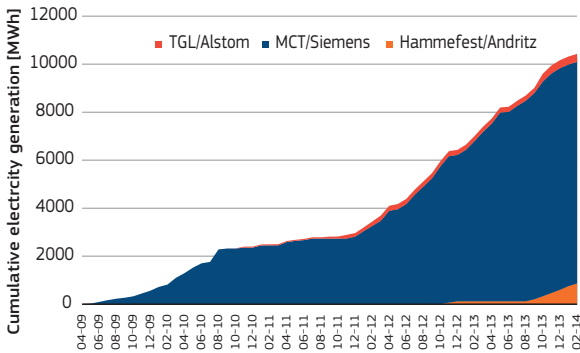

Fig. 8: Electricity generation from tidal energy converters in the UK. Source: Ofgem 2014

Electricity production and capacity factors achieved by the sector have offered encouraging signs for a relatively young industry, and have facilitated investments in the sector. One of the key strengths of the tidal energy industry, in comparison with other ocean energy technologies, has been its capacity to attract a number of large OEMs. The presence in the market of OEMs has certainly allowed the sector to gain a certain momentum towards the formation of a market, with a first array project currently under construction (Offshore Wind 2014).

However, concerns with regards to the cost of the technology, its rate of development and reaching

¹ The reference descriptions for TRLs adopted in this document correspond to the definitions in the Horizon 2020 framework (Section 5.2).
² The SeaGen device deployed in Strangford Lough was subject to an adaptive management system to reduce potential impacts on marine mammals, which initially required complete shut-off of the device when a mammal approached the turbine at a 100 m distance, but was progressively reduced.

financial close have already forced OEMs to divest their interests in tidal energy, as witnessed in the case of MCT/Siemens (Business Green 2014). Siemens pointed to delays in the formation of the market and of the supply chain as the main cause of its exit from the sector.

In short, the tidal market has yet to take off. Tidal energy is still an emerging and niche sector, which has still to overcome one major barrier: finalising its technology for commercial roll-out, and reaching financial close for the deployment of pre-commercial and first-of-a-kind arrays.

At the current stage, as a matter of fact, most deployment activities are looking at single device and small pre-commercial arrays. An overview of expected tidal deployments in Europe for the period 2012–2014 is presented in Figure 9, highlighting the status of each announced deployment, mostly in the area of 0.5–2 MW.

2.3.2 Aiding development and deployment

Local agencies, national governments and the European Union are acting on different levels to facilitate the creation and the establishment of a tidal energy and broader ocean energy market, including the creation of ad-hoc infrastructures such as test centres, facilitating leases for seabed, establishing funds for first-of-a-kind array demonstrations and implementing capital support systems.

In the last few years a number of initiatives have been launched to help drive the ocean energy sector towards arrays deployment and meet the NREAP targets. Tidal projects were awarded funds through both EU and national schemes, such as the EU

NER 300 (New Entrants' Reserve) programme, the UK Marine Energy Array Demonstrator (MEAD) and France's ADEME's funds for the development of tidal parks (Table 8). It is important to notice that access to these funds is subject to stricter conditions compared to R&D funds, with funding subject to the operating start date and to the amount of electricity produced, and often they require the developer to find further financing. Both the tidal projects that were awarded NER 300 funding from the EU are still in the development phase and are expected to commence operation in the last quarter of 2016. The Kyle Rhea project, an 8 MW array put forward by MCT/Siemens, was granted EUR 10 million of upfront funding (Commission Decision C(2014) 383 2014).

Of the two projects awarded funds under DECC flagship Marine Energy Demonstrator Array (MEAD) funds, only the MeyGen project has reached financial close, having raised over 50 m GBP to allow the project to take off. The array is currently under construction (Offshore Wind 2014). On the other hand, the postponement of the operating date past the 2016 deadline has forced DECC to withdraw its grant for the Skerries array, which was later abandoned by Siemens (Tidal Today 2014a). The exit of Siemens from the sector may also affect the Kyle Rhea project; however, no announcements have been made with regard to this yet. In December 2014 ADEME announced winners for the construction of two pilot tidal projects in France: a 5.6 MW array expected to be operational by 2017, employing four Alstom Oceade turbines, and a 14 MW array composed of seven OpenHydro 2 MW turbines. The total support provided by ADEME is EUR 103 million, whilst the total project costs are expected to be in the area of EUR 210 million for the 20 years of life of the arrays (ADEME 2014).

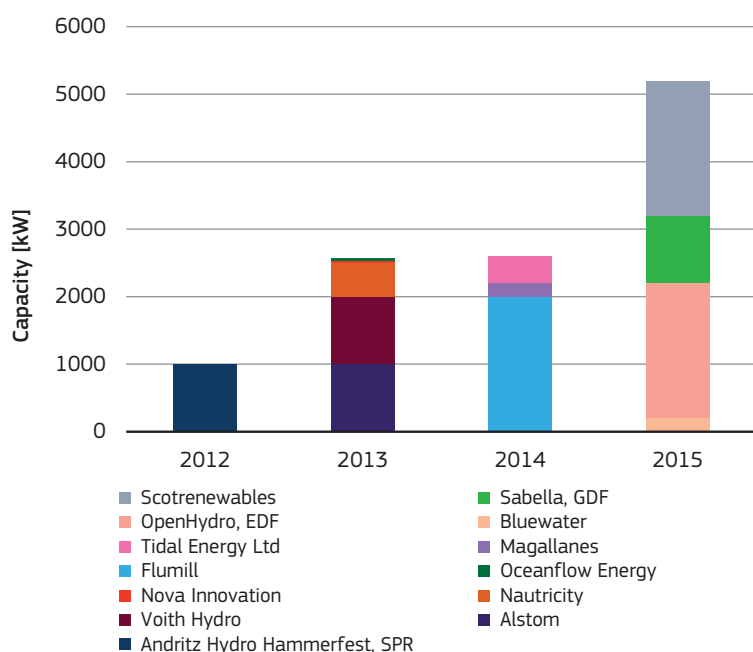

Fig. 9: European tidal deployment 2012–2014

Table 8: Descriptions of most common generators for tidal energy applications

Project Name	Location	Capacity	Funding Awarded	Funding Body	Expected Operation Date	Status and Updates
Sound of Islay	Islay, Scotland, UK	10 MW	20.65 m EUR	NER 300/EU	31/10/2016	Project put forward by ScottishPower Renewables and to employ Andritz Hydro and Alstom turbines.
Kyle Rhea	Isle of Skye, Scotland, UK	8 MW	16.77 m EUR	NER 300/EU	31/12/2016	The EU has approved up-front funding for this project of 10 m EUR.
MeyGen	Pentland Firth Inner Sound, Scotland	6 MW	10 m GBP	MEAD/UK	Jan–Jun 2016	The project has reached financial close for the development of phase 1A (6 of 86MW). Construction was expected to begin in the fourth quarter of 2014. DECC and The Crown Estate are among the financing sources.
Skerries Array	Anglesey, Wales, UK	10 MW	10 m GBP	MEAD/UK	Jan–Jun 2016	Project halted following delays to expected operation date.
Nephtyd	France	5.6 MW	Undisclosed	ALSTOM / GDF SUEZ / ADEME	31/12/2017	ADEME has awarded Alstom/GDF Suez and OpenHydro/DCNS/EDF funds for the creation of pilot tidal projects in France. The total sum provided by ADEME is 103 m EUR, and the total costs over 20 years are expected to be 210 m EUR.
Normandie Hydro	France	14 MW	Undisclosed	OpenHydro / DCNS/ EDF/ ADEME	31/12/2018	ADEME has awarded Alstom/GDF Suez and OpenHydro/DCNS/EDF funds for the creation of pilot tidal projects in France. The total sum provided by ADEME is 103 m EUR, and the total costs over 20 years are expected to be 210 m EUR.

Sources: Commission Decision C(2014) 383 2014; France Energies Marines 2014; ADEME 2014; Tethys 2014b; Tethys 2014c

2.3.3 Future developments

The tidal sector is continuously looking to increase installed capacity. A wide number of projects have been announced in the last few years, accounting for over 1500 MW of projected capacity in Europe (Corsatea & Magagna 2013). Only a small fraction of them has actually been commissioned or reached financial close. It has to be noted that the expected capacity of a project does not necessarily relate to its initial development. For example, projects such as MeyGen could reach up to 398 MW in size; however, its initial development phase has been approved for up to 86 MW and received a grid licence for up to 15 MW (MeyGen 2014b). Similarly, DP Energy have announced plans for the Fair Head and Islay arrays, with an aspirational combined capacity of 400 MW, currently planned for a 130 MW capacity (DEME 2014).

In the UK alone, The Crown Estate has already leased 26 zones for tidal energy development, accounting for over 1200MW. In addition, in July 2014 the lease of 11 new wave and tidal zones, including sites identified to become demonstrations zones, was announced (The Crown Estate 2014).

Three of the four demonstration zones selected for Scotland are dedicated to tidal projects and were chosen to be developed in collaboration with local communities (The Crown Estate 2014). Five more sites are currently under construction in France, with the expectation of devices being operational by 2016. Small-sized arrays have been announced for construction on dikes in the Netherlands in 2016. By 2018, Europe could see its tidal installed capacity increasing to about 40 MW, a significant step forward for the development of a tidal energy market (Figure 10).

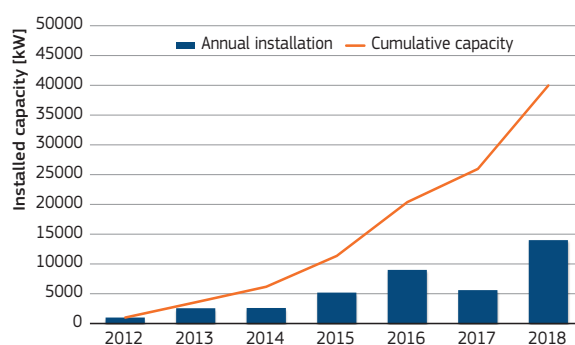

Fig. 10: Expected tidal developments until 2018

It is undeniable that tidal energy is making slow but steady progress towards the deployment of pre-commercial arrays, with first-of-a-kind projects receiving both national and European support. However, on the other hand, it is clear that the sector needs to identify better strategies to attract investment and secure financing for the first arrays to be deployed. In this context, the success of the MeyGen consortium in raising the necessary capital to start Phase 1A of the array should be considered as a milestone, providing an encouraging sign for the whole sector. The issues related to the financing of ocean energy projects have been highlighted in a recent EU communication on ocean energy, with a dedicated 'stream' in the newly set-up Ocean Energy Forum (COM(2014) 8 final 2014).

Table 9 gives an overview of upcoming tidal energy projects in Europe. Nine of the 31 projects are expected to become operational by the end of 2016, whilst the majority are still in planning or development.

2.4 Economic Aspects and Cost Components

A key aspect in the evaluation of the performance of tidal energy technologies is how they compare against other renewable energy sources (RESs) and conventional energy sources. The long-term aim for tidal energy is to provide a significant share of the future European energy supply by becoming cost competitive.

The JRC energy technology reference indicators (ETRIs) are parameters used to identify up-to-date cost and performance characteristics of the present and future European energy technology portfolio. With regards to tidal energy, they provide both techno-economic data projections for the modelling community and policy makers (including capital and operating costs), and a useful tool for policy makers to help identify future priorities for research, devel-

Table 9: Leased tidal energy projects in Europe

Name	Capacity (MW)	Status	Project Developer
Bluemull Sound	0.5	In planning	Nova Innovation Ltd
Brough Ness	100	In planning	Sea Generation (Brough Ness) Ltd
Cantick Head	200	In planning	Cantick Head Tidal Development Ltd
Esk Estuary	0.6	In planning	GlaxoSmithKline Montrose plc
Inner Sound (MeyGen)	392	In planning	MeyGen Ltd
Isle of Islay	30	In planning	DP Marine Energy Ltd
Kyle Rhea	8	In planning	Sea Generation (Kyle Rhea) Limited
Mull of Kintyre	3	In planning	Argyll Tidal Ltd
Ness of Duncansby	100	In planning	ScottishPower Renewables UK Ltd
Sanda Sound	0.035	In planning	Oceanflow Development Ltd
Sound of Islay	10	In planning	ScottishPower Renewables UK Ltd
St David's Head	10	In planning	Tidal Energy Developments South Ltd
Westray South	200	In planning	Westray South Tidal Development Ltd
Afsluitdijk	3	In development	Tocado, Tidal Test Centre
Fair Head	100	In development	DP Marine Energy & DEMA Blue Energy
Lashy Sound	30	In development	Scotrenewables Tidal Power
Nephyd	5.6	In development	Alstom/GDF Suez
Normandie Hydro	14	In development	OpenHydro/DCNS/EDF/ADEME
Perpetuus Tidal Energy Centre	20	In development	Isle of Wight Council
Ramsey Sound	1.2	In development	Tidal Energy Limited
Fromveur	1	In development	Sabella/IFREMER/Veolia Environnement/Bureau Veritas
Norway	2	In development	Flumill
Raz Blanchard	12	In development	GDF Suez/Voith Hydro/CMN/Cofely Endel/ACE
Inner Sound (Meygen)	6	In construction	MeyGen Ltd
Strangford Lough (Minesto 2)	0.003	In construction	Minesto AB
EMEC Shapinsay Sound	n.a.	Nursery facilities	European Marine Energy Centre Ltd
Lynmouth	1.6	Interrupted	Pulse Tidal Ltd
Skerries, Anglesey	10	Interrupted	Sea Generation Ltd
EMEC Fall of Warness	10	Operational	European Marine Energy Centre Ltd
Ness of Cullivoe	0.03	Operational	Nova Innovation Ltd
Strangford Lough (Minesto 1)	0.003	Operational	Minesto AB
Strangford Lough (SeaGen)	1.2	Operational	Sea Generation Ltd

Sources: The Crown Estate 2014; France Energies Marines 2014

■ Projects expected to become operational by the end of 2016 ■ Projects of uncertain status ■ Interrupted projects

opment and demonstration (RD&D). In the context of leading the Strategic Energy Technologies Information System (SETIS), the JRC has identified ETRIs for different current and future energy technologies (ETRI 2014). It shall be noted that, given the pre-commercial stage of tidal energy, the ETRIs are projections based on existing literature containing considerable uncertainties.

In the following subsections, an overview of the tidal energy cost components, future costs predictions and estimates of the levelised cost of energy (LCOE) are given.

2.4.1 CAPEX and cost components

Through a review of the existing data available, the different cost components to be included in the capital expenditure (CAPEX) estimate for tidal energy have been identified as follows:

- Civil and structural costs
- Major equipment costs
- Balance of plant costs
- Electrical and I&C supply and installation
- Project indirect costs
- Development costs.

An overview of the CAPEX breakdown is presented in Figure 11. The identification of cost components is essential to help identify strategies for cost reductions through concerted effort, increased supply chain pooling, and increased efficiency and reliability at subcomponent level. Main CAPEX components are mechanical equipment costs, followed by civil and structural costs.

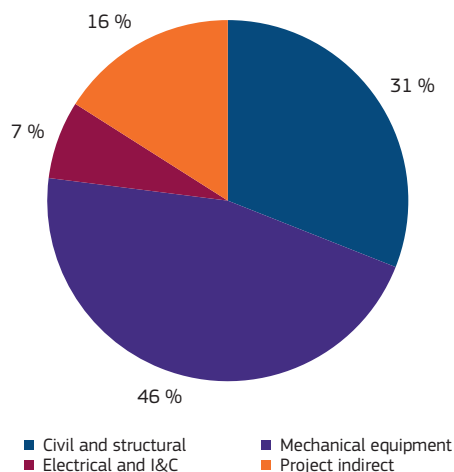

Fig. 11: CAPEX breakdown for tidal power. Source: ETRI 2014

2.4.2 Future power ratings

The future power ratings of tidal energy plants are very uncertain; hence, ranges are given. It should be noted that most of the current literature provides cost information for 10 MW arrays once 10 MW of existing capacity is already in place. Thus, it is likely that initial costs may be higher. For this reason, the upper limits of current CAPEX estimates are used in the near term, whilst long-term estimates align with future predictions. An overview of techno-economic data of current and future projections is presented in Table 10.

2.4.3 LCOE predictions

The LCOE provides a further parameter for compar-

Table 10: Techno-economic data for tidal energy

	Unit	2010	2020	2030	2040	2050
Technical						
Net electrical power ^a	MWe	10	10–20	20–30	30–40	50–400
Max. capacity factor	%	36	45	47	47	50
Avg. capacity factor	%	34	37	40	42	45
Technical lifetime	Years	20	20	20	20	20
Costs						
CAPEX ref.	EUR ₂₀₁₃ /kWe	10700	4400	3400	2100	1900
CAPEX low	EUR ₂₀₁₃ /kWe	9300	3600	3000	1800	1700
CAPEX high	EUR ₂₀₁₃ /kWe	12300	5500	3100	2800	2500
Quality of CAPEX estimate				Low		
CAPEX learning rate	%	12	12	12	12	12
FOM	% of CAPEX ref.	3.4	3.6	3.8	4.3	4.9
Evolution						
Max. potential	GWe	0.04	0.4	2.9	3.1	10

^a Current estimates for tidal energy plants focus on the development of 10 MW arrays; however, projects of up to 400MW have been announced, but no clear timescale is currently available. Source: ETRI 2014

ison of renewable energy sources against conventional energy sources. The LCOE gives a projection of the cost of electricity from a tidal energy farm over its lifespan, against the expected annual energy production (AEP). LCOE is therefore influenced by the performance of the technology and by all the expenditures necessary to develop, construct and maintain a project.

Figure 12 presents LCOE predictions for tidal energy technology. LCOE was calculated using the ETRI parameters data, as reported in Table 10 (ETRI 2014), taking into account a 12 % CAPEX learning rate, as experienced by other offshore energy technologies. The reference LCOE associated with tidal energy currently ranges between 50 c EUR/kWh and 65 c EUR/kWh. Taking a value of 10–15 c EUR/kWh as the LCOE benchmark for mature RESs, it is possible to see that reference tidal technologies could achieve commercial competitiveness once approximately 1.5–5 GW of cumulative capacity have been installed, in line with the findings of SI Ocean (SI Ocean 2013b). Lower LCOE could be achieved in the best-case scenario, in which the technology is installed in high resource areas with high operational capacity factors and low capital expenditure.

The convergence of tidal LCOE estimates towards competitive values depends on the operational conditions, since a good resource will allow for low LCOE. In addition, a concerted effort by the sector is needed to overcome existing barriers that are currently hindering its development, such as:

- Technology demonstration and performance: the industry should drive towards enhancing the performance of single and array installations, aiming to provide reliable, cost-competitive technologies.
- Increased design consensus and upscaling: unlocking the possibility of cost reduction through economies of scale and broader engagement with supply chains.

The sector is showing that initiatives are being undertaken to further its development and establish tidal energy as a reliable and economic energy technology in the European energy mix. Actions and activities that are currently being undertaken to facilitate the commercialisation of tidal and ocean energy technologies will be discussed in Chapter 5.

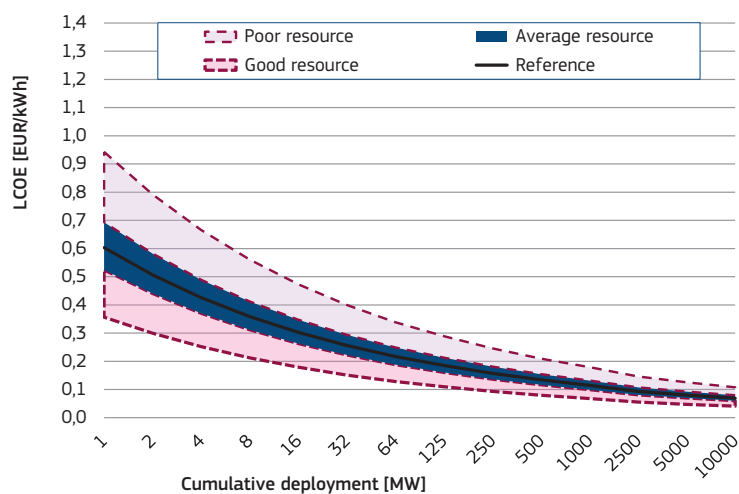

Fig. 12: LCOE predictions for tidal arrays. Source: JRC, based on ETRI 2014

3 WAVE ENERGY

Wave energy presents the form of ocean energy with the highest deployment potential in European waters, associated with a global potential 30 times higher than that of tidal energy. The potential market for wave energy has attracted the interest of researchers since the early nineteenth century; however, it is only since the 1970s that considerable R&D efforts have been dedicated to developing viable and reliable wave energy converters (WECs).

In many instances wave and tidal energy have been taken into consideration jointly; however, their development paths and operating principles have little in common. Whilst TECs present many similarities to wind turbines, different types of WEC have been proposed over the years, differentiated mainly by the way the devices would react to the force exerted by waves. The majority of proposed devices have been designed to generate electricity; however, a limited numbers of concepts have been developed for desalination purposes. Within the scope of this report, focus will be primarily given to electricity-generating technologies.

The abundance of wave energy resources worldwide, which is significant at latitudes greater than 30°, has prompted a widespread interest in the development of wave energy technologies. In Europe, the most resourceful areas can be found across the Atlantic Arc, the stretch of coastline facing the Atlantic Ocean. Other areas, such as the North and Mediterranean seas, offer limited resources compared to the Atlantic Ocean, but with a potential for future developments. The JRC has identified ten countries in Europe with an active interest in developing wave energy technologies (Corsatea & Magagna 2013): the United Kingdom, Ireland, France, Spain, Portugal, Sweden, Denmark, Italy, Finland and Norway.

Similarly to tidal technologies, wave energy has not yet reached the level of technical maturity to ensure penetration in the energy market. Current development appears to be slower in comparison to TECs; however, some technologies are already progressing towards the installation of multiple-device arrays. Wave energy technologies are primed to reach commercial breakout within the next decade, to deliver a further option in the creation of a sustainable energy system and to provide increased energy security for Europe.

3.1 Technology Status

Many different concepts of WEC have been developed since the 1970s, offering a wide variety of designs, energy extraction systems and applications. Accordingly, classification of wave technologies has evolved to encompass new developments and progress in the sector. For clarity and consistence, the EMEC classification is used in this report, in which devices are classified by their operating principle. However, it is important to note that the location at which a device is meant to operate (offshore, near-shore and onshore environments) places a strong emphasis on how a WEC is classified, as well as on the type of structure and foundation that may be required.

In terms of research effort, there is currently no leading category of wave energy device. A review of R&D efforts according to device type is presented in Figure 13, indicating that the bulk of research revolves around point absorbers, attenuators and oscillating wave surge converters (OWSCs). The lack of convergence in terms of design of wave energy converters has already been highlighted as one of the main barriers currently hindering the development of the sector (MacGillivray *et al.* 2013). The development of wave energy conversion has followed a different pattern compared to that of tidal energy, and has not benefited from technology and knowledge transfer from wind energy.

Wave energy developers have focussed on designing WECs that could harness directly the most powerful resources offshore, adding further complexity to the design challenges of a reliable wave energy conversion device. IRENA has shown that 64 % of WECs have been designed for offshore operation and 36 % for near-shore and onshore operation (IRENA 2014b). However, despite a number of wave energy facilities being developed to facilitate demonstration testing of WECs, no installation has currently taken place further than 5 km from shore and in water depths of more than 75 m (Corsatea & Magagna 2013).

Of the various types of wave energy converters, the OWC device is the oldest and also the one that has received most attention in the past. In Europe there are three onshore installations of OWC devices, accounting, however, for only 840 kW of installed capacity. Despite having being operational for over a decade, some of the sites were actually intended as test sites for the improvement of turbine designs and control strategies. Offshore or floating OWC devices have not achieved the same level of technical maturity.

Table 11: Wave energy converters classification, according to EMEC 2014b

Device Type	Class	Description
Attenuator	A	Attenuators exploit the incoming wave power to generate an oscillatory motion between adjacent structural components. The resulting motion activates the power take-off (PTO), either by pumping high-pressure fluids through a hydraulic motor or by operating a direct-drive generator. Attenuators are designed to operate offshore, and are commonly surface floating, although fully submerged devices have been proposed.
Point Absorber	B	Point absorbers are normally heaving/pitching devices that exploit the relative motion between an oscillating body and a fixed structure or component, which can be either moored to the seabed or installed on the seabed through a large foundation mass. Point absorbers are normally smaller in dimension compared to other WECs. They are non-directional devices, as their performances are not affected by wave directionality.
Oscillating Wave Surge Converter (OWSC)	C	Oscillating wave surge converters exploit the surging motion of near-shore waves to induce the oscillatory motion of a flap in a horizontal direction. OWSCs are bottom-mounted devices, although prototypes of floating OWSC are already under development.
Oscillating Water Column (OWC)	D	Oscillating water columns (OWC) use the oscillatory motion of a mass of water induced by a wave in a chamber to compress air to drive an air turbine. The water column thus acts as a piston on the air volume, pushing it through the turbine as the waves increase the water level in the chamber, and drawing it as the water level decreases. OWCs are one of the first types of wave energy converters developed, and different operational ones are installed onshore in self-contained structures. Floating OWCs have been tested and are currently under development for offshore deployment.
Overtopping	E	Overtopping devices or terminator WECs convert wave energy into potential energy. This is stored in a reservoir and used to drive low-head turbines. The design of overtopping devices facilitates waves breaking on a ramp to be collected in a reservoir above the free water surface. Water contained in the reservoir can produce energy by flowing through a low-head hydraulic turbine. Overtopping devices have been proposed to be built for integration in breakwaters, for self-contained onshore operation and for offshore installation.
Submerged Pressure Differential	F	Submerged Pressure Differential devices are fully submerged devices, exploiting the hydrodynamic pressure induced by waves to force an upward motion of the device, which then returns to its starting position once the pressure differential is reduced.
Bulge Wave	G	Bulge wave devices use wave-induced pressure to generate a bulge wave within a flexible tube. As the bulge wave travels within the device it increases in size and speed. The kinetic energy of the bulge is used to drive a turbine at the end of the tube.
Rotating Mass	H	Rotating mass converters exploit the relative motion of waves to induce pitching and rolling in a floating body, thus forcing the rotation of an eccentric mass contained within the device. As the mass rotates it drives an electrical generator.
Other	I	Novel wave energy devices currently under development that do not fit any of the above categories.

Sources: SI Ocean 2013a; EMEC 2014b

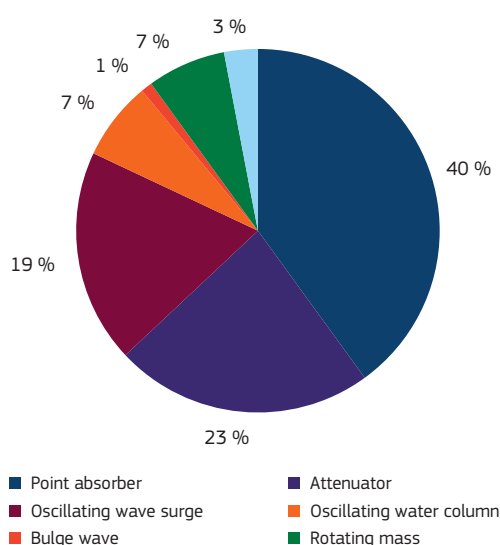

Fig. 13: Distribution of R&D efforts according to wave energy technology type. Source: JRC 2014

Other devices have reached and are currently in full-scale operational testing, such as the OWSC devices

Oyster, from Aquamarine Power, and Wave Roller, from AW-Energy; point absorbers Sea-tricity and Seabased; and Pelamis P2, an attenuator developed by Pelamis Wave Power. Some developers have been able to demonstrate the survivability of their technologies by sustaining long operational hours, and current tests are focussing on identifying reliable components and improving performances. Pelamis recently announced it had exported 250 MWh to the grid (Pelamis 2014), whilst Oyster 800 has been installed at EMEC for over two years. Whilst devices have been tested in operational environments, they have not reached and shown the same level of technological maturity as tidal devices. In contrast with the tidal energy sector, the wave energy industry has seen a number of OEMs pulling out of the sector, given mainly to the slow technical progress of the technologies. Despite a slowing trajectory, caused by the economic/financial crisis and technical challenges, wave energy developers have, however, been able to deploy their devices in test conditions and to feed electricity to the grid.

3.2 Technology Developments

The main hurdle for the wave energy industry is to prove the full reliability and operability of its devices in open waters. Bloomberg New Energy Finance has reduced the expected global installed capacity of wave energy to 21 MW by 2020, a drop of 72 % compared to 2013 forecasts (BNEF 2014). An increase of deployment rate is therefore expected in the period 2014 to 2020, in order to strengthen the position of wave energy as a secure source of renewable energy in a changing European energy market. There is the need for a paradigm shift in the sector, to ensure that the full potential of wave energy is harnessed. The wide variety in proposed technologies does not allow the same knowledge sharing and engagement with the supply chain that is currently being experienced by the tidal sector. Two different trends can, however, be witnessed in the sector: small-scale devices and increased collaboration (SI Ocean 2013a), which will be discussed in the following sections.

3.2.1 Small-scale devices

Many current and first-generation WECs have been designed to operate in most resource-rich sites to exploit the higher energy density contained in waves. Many concepts developed have nominal power > 750kW, with some proposed designed, such as the Wave Dragon, rated at 7 MW (Cruz 2008). Operating in high-energy environments poses many questions with regards to the survivability of devices, since increased wave power corresponds to increased loads and extreme waves that need to be sustained by the machines. A number of wave energy developers have proposed the development of small-scale devices, offering a wide range of potentials benefits:

- Increased survivability: low-rated devices do not need to operate in the most powerful resources to generate electricity. As a consequence, WECs sustain lower loads on the structures, which should increase their survivability during operations.
- Smoother learning process: building small-scale devices allows developers to reduce their risk in deployment at sea, and offers them the possibility to try and to test their devices before upscaling to higher power ratings. The risk and costs associated with the deployment of demonstration WECs are high and could hinder the financial stability of wave energy developers (Renew Economy 2014).
- Maintenance: small-scale devices are associated with reduced maintenance, since they are designed to operate in farms and a defect to one unit may not affect the overall array performance, hence reducing the time necessary for maintenance.

Seabased A. B. and new entrants in the market, such as 40SouthEnergy and Albatern, have all started developing and testing small-scale devices. Seabased is currently developing the 10 MW Sotenas project and has already installed the first ten direct-drive generating units out of the 340 expected (Fortum 2014a).

The development of small-scale WECs could help the sector in reducing the risk associated with the demonstration phase of the technology; however, it is of paramount importance that the energy production and associated costs are viable. It has to be noted that often renewable energy developers aim to deploy first in locations with best resource conditions and lower costs (Held *et al.* 2006), explaining the need for developing MW-scale devices. This approach, however, does not take into account technology learning and the corresponding reduction of investment costs that are essential for emerging renewable energy technologies, and wave energy in particular.

3.2.2 Increased collaboration

The wave energy sector currently presents a wide variety in the type of concepts developed, on how they operate and convert energy into electricity. As discussed earlier, the lack of design consensus has already been highlighted as one of the barriers that are currently hindering the sector's development and engagement with the supply chain to find reliable and economic solutions. The sector is already employing and testing readily available components (Aquamarine Power 2014); however, a further step towards standardisation was recently announced when three different wave energy developers (Aquamarine Power, Albatern and Carnegie) joined forces with Bosch Rexroth for the development of a standardised wave energy power take-off (PTO), the WavePod (Bosch Rexroth 2014). The collaboration also includes academic institutes and energy utilities. The aim of the consortium is to solve collectively issues that are beyond the capability of single developers. A one-tenth-scale PTO is already under testing at Aachen University, and full-scale installation in water is expected for 2016.

3.2.3 Components and subcomponents

The variance of WEC designs does not allow for the identification of the structure of a general wave energy device, as for tidal energy technologies. There are great differences between device types in terms of materials employed, PTO systems and types of foundation. A more detailed look at existing wave energy prototypes provides further insight into how the wave energy sector is developing its technologies. Regardless of type, each WEC comprises the following three elements:

- A prime mover: a structural component reacting to the incoming wave power, activating a PTO or inducing the movement of other structural components.
- Moorings or foundations, according to the location and application of the device.
- Power take-off: single or multiple PTOs that can be embedded within the device or located on the seabed/shore.

In addition, power delivery components play a significant role in the final structure of the device. These consist of either electrical components (cable and connectors) or hydraulic components (high-pressure pipes, valves and accumulators), depending on the WEC and PTO type.

3.2.3.1 Prime mover, structure and application

The prime mover is the main component of a WEC, which interacts with waves for the conversion of wave energy into mechanical energy first, and then into electricity. Designs and shapes of prime mover vary substantially according to the type of WEC, as they are intended to maximise its hydrodynamic efficiency and therefore power conversion, and according to the application of the device. For example, heaving point absorbers tend to be a small size in comparison to attenuators, overtopping or OWSC devices. A review of existing prototypes suggests that steel is the most employed material for wave energy device fabrication (Figure 14).

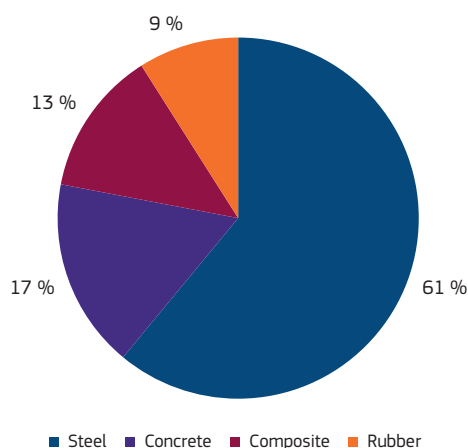

Fig. 14: Main material employed for WEC prime mover. Source: JRC 2014

An important issue, in terms of survivability of the device, concerns the application of the device: offshore, near-shore and onshore, with offshore locations associated with more powerful sea states compared to near- and onshore installations. Requirements in terms survivability of device tend to increase as installations move further offshore, both in order to withstand rougher sea climates and to reduce maintenance operations. Most of the WECs currently under development are designed for offshore installation (Figure 15).

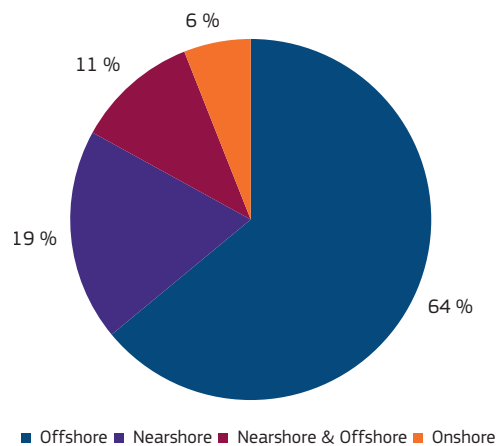

Fig. 15: Wave energy applications. Source: IRENA 2014b

3.2.3.2 Moorings and foundations

As a direct consequence of the offshore ambitions of the wave energy industry, the majority of the concepts developed will be anchored to the seabed by using mooring lines for floating WECs and foundation systems for bottom-standing devices (Figure 16).

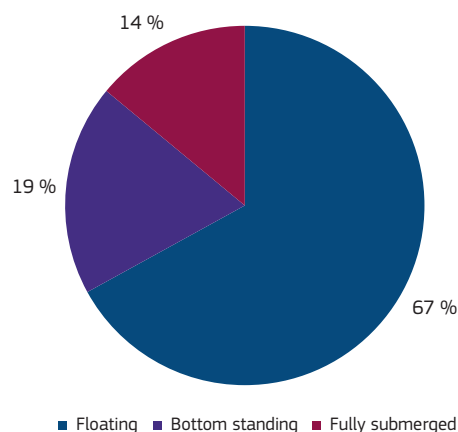

Fig. 16: Installation of WECs. Source: IRENA 2014b

Moorings play a key role in assuring the station-keeping of devices and in minimising the combined effects of wave and wind loads on devices, whilst allowing for movement in one or more direction for wave energy extraction (Weller *et al.* 2013). This latter requirement comprises the main difference between moorings for WECs and those for other conventional offshore applications (Weller *et al.* 2014), with existing guidelines, such as the DNV-OS-E301 'Position Mooring', developed for the oil and gas sector, which are applied to ocean energy installation. Moorings and foundations constitute about 10 % of CAPEX for wave energy projects; thus identifying and optimising their structures would provide an avenue for cost reduction for the technology.

3.2.3.3 Power take-off

A large variety of PTO has been developed for WECs. One of the key aspects of PTO and wave energy conversion is presented by the necessity of converting the irregular high-power, low-speed energy contained in waves to the requirements of the grid. A review

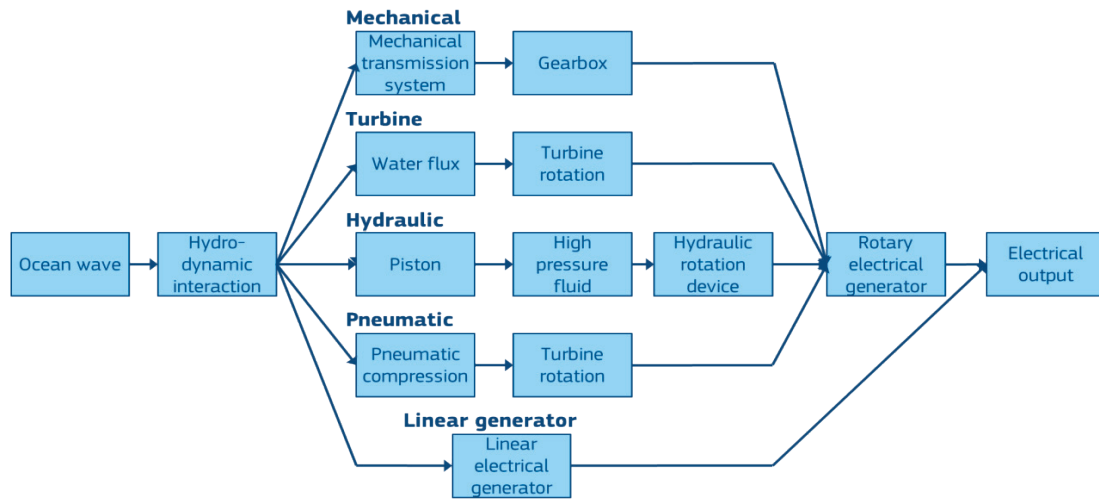

Fig. 17: Wave energy conversion methods in electricity. Source: Grimwade et al. 2012, adapted

Table 12: Wave energy systems and related PTO

Device Type	Class	Type of PTO
Attenuator	A	Hydraulic circuit
Point Absorber	B	Hydro turbine, hydraulic circuit, linear generator
OWSC	C	Hydro turbine, hydraulic circuit
OWC	D	Air turbine
Overtopping	E	Low-head hydraulic turbine
Submerged Pressure Differential	F	Hydraulic circuit, linear generator
Bulge Wave	G	Hydro turbine, hydraulic circuit
Rotating Mass	H	Mechanical

Source: Grimwade et al. 2012

of PTO systems has been presented by Cruz (2008), Drew et al. (2009), Lynn (2013) and by the MaRINET project (Grimwade et al. 2012). It is generally recognised that the development of a wave energy PTO is more challenging compared to TECs (Lynn 2013), given the wide variety of systems developed. It shall be noted that, in a few cases, wave energy converters have not been employed for the generation of electricity but for desalination purposes, as proposed by Aquamarine Power and Carnegie. These cases will not be taken into account further within this report.

Five different classes of PTO have been employed for wave energy conversion (Figure 17):

- Turbines, including air turbines and hydraulic turbines
- Hydraulic systems, including accumulators, piston motors and vane motors
- Linear generators: direct-drive generators that exploit the generation of a magnetic field
- Mechanical PTOs
- Pneumatic PTOs.

The choice of the particular PTO is dependent on the type of WEC, and so are its dimensions. The relation between WEC and PTO is given in Table 12.

Hydraulic systems represent the most common wave energy PTOs; a breakdown of the different types of PTO employed in wave energy is presented in Figure 18. Even within a single class of PTO the variation of systems and components employed is vast, and it is difficult to provide a more in-depth assessment of wave energy PTOs. A step towards the standardisation of PTOs has been made by the creation of the WavePod consortium, involving Bosch Rexroth and different wave energy developers (Section 3.2.2).

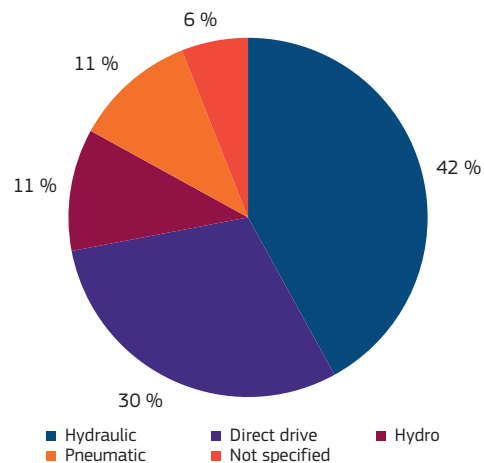

Fig. 18: PTO employed in wave energy conversion. Source: IRENA 2014b

Table 13: Identified suppliers for WECs according to component and service

Company	Fabrication	PTO & Generator	Electrical & Automation	Bearings	Marine Operations	Hydraulic Components	Certification	Coating	Diagnostic
40South Energy			ABB						
Albatern	Zeus Engineering, Purepipe	Bosch Rexroth			Mallaig Marine	Mallaig Marine			
Aquamarine Power	Burntisland Fabrications	Bosch Rexroth	ABB	Hutchinson	Fugro Seacore	Hunger Hydraulics	DNV GL		BAE Systems
AW Energy			Metso				DNV GL, Lloyds Register	Hempel	
Carnegie		Bosch Rexroth		Hutchinson					
Fred Olsen Ltd	A&P Falmouth, Supacat	Siemens			SeaRoc		DNV GL		
Langlee Wave Power	Repraval						DNV GL		
Pelamis Wave Power	Barnshaws		KTR Couplings	Schaeffler					
Seatricity	A&P Falmouth								
Wave Star Energy									
Wello OY	Riga Shipyard	The Switch	Veo	Schaeffler		Hydac, Seaproof Systems			

3.2.3.4 Supply chain engagement

The large variety of WECs developed has often been identified as one of the main bottlenecks of the sector, limiting engagement with the supply chain and thus minimising cost reduction through economies of scale or mass manufacturing. An overview of how wave energy developers have engaged with the supply chain is presented in

Table 13. The availability of suppliers' information is limited compared to the tidal case. However, it is possible to see that key OEMs are still engaging with the wave energy industry to develop and adapt engineering solutions for wave energy.

3.3 Market and European Leadership

3.3.1 Global development

A large number of developers have invested in wave energy R&D. In 2011, over 100 wave energy developers were identified (Magagna 2011), and currently EMEC lists 170 wave energy developers worldwide (EMEC 2014b). About 45% of wave energy developers are based or are currently developing projects in the EU, which is at the forefront of wave energy development and also hosts the majority of wave energy infrastructure. The numbers give an idea both of the global effort in developing reliable wave energy technologies as well as the variety of designs proposed, although it shall be noted that only a few of them have reached scale or prototype testing.

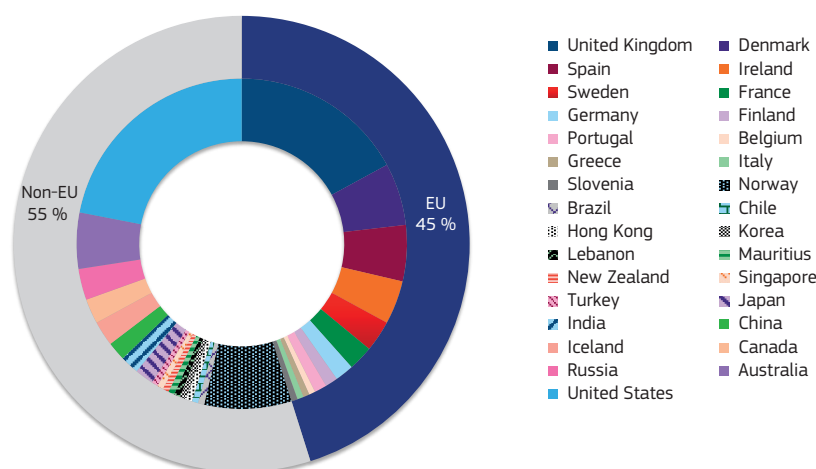

Fig. 19: Distribution of wave companies in the world. Source: EMEC 2014b

Table 14: Shortlist of wave developers identified by JRC

Company Name	Model	Operational Testing	Country	Website
40South Energy	R115, Y series, D series	Full-scale	Italy/UK	www.40southenergy.com
Albatern	SQUID	Part-scale	UK	http://albatern.co.uk/
AquaGen Technologies	SurgeDrive	Small-scale	Australia	www.aquagen.com.au
Aquamarine Power	Oyster	Full-scale	UK	www.aquamarinepower.com
Atargis Energy		Small-scale	USA	www.atargis.com
AW Energy	WaveRoller	Full-scale	Finland	www.aw-energy.com
AWS Ocean Energy	AWS-III, Archimedes Wave Swing	Full-scale	UK	www.awsocan.com
BioPower Systems Pty Ltd	bioWave	Small-scale	Australia	www.biopowersystems.com
Bombora WavePower	Bombora WEC	Small-scale	Australia	http://www.bomborawavepower.com.au/
Carnegie Wave Energy Ltd	CETO	Full-scale	Australia	www.carnegiwave.com
Columbia Power Technologies	Manta, SeaRay	Part-scale	USA	www.columbiapwr.com
COPPE Subsea Technology Laboratory		Part-scale	Brazil	www.coppenario20.coppe.ufrj.br/?p=805
DexaWave A/S	DexaWave	Small-scale	Denmark	www.dexawave.com
Eco Wave Power	Wave Clapper, Power Wing	Part-scale	Israel	www.ecowavepower.com
Floating Power Plant AS		Part-scale	Denmark	www.floatingpowerplant.com
Fred Olsen Ltd	FO3, Bolt, Bolt 2 Lifesaver	Full-scale	Norway	www.fredolsen-renewables.com
Intention AS	ISWEC, IOWEC	Full-scale	Norway	http://www.intention.com/
Kymaner	Kymanos	Part-scale	Portugal	http://www.kymaner.com/
Langlee Wave Power	Rubusto	Full-scale	Norway	www.langlee.no
LEANCON Wave Energy	MAWEC	Small-scale	Denmark	http://www.leancon.com/
Neptune Wave Power	Neptune WECD	Part-scale	USA	http://www.neptunewavepower.com/
Ocean Energy Ltd	OEBuoy	Part-scale	Ireland	www.oceanenergy.ie
Ocean Harvesting Technologies		Full-scale	Sweden	http://www.oceanharvesting.com/
Ocean Power Technologies	PowerBuoy	Full-scale	USA	www.oceanpowertechologies.com
Oceantec	Oceantec WEC	Small-scale	Spain	www.oceantecenergy.com
Offshore Wave Energy Ltd (OWEL)	OWEL WEC	Small-scale	UK	www.owel.co.uk
Oscilla Power	Wave Energy Harvester	Small-scale	USA	www.oscillapower.com
Pelamis Wave Power ^a	Pelamis	Full-scale	UK	www.pelamiswave.com
Perpetuwave	Wave Harvester	Part-scale	Australia	http://www.perpetuwavepower.com/
Pico Plant EU Consortium	Pico Plant OWC	Full-scale		
RESEN Waves	LOPF Buoy	Small-scale	Denmark	http://www.resen.dk/resen_standard.asp?pageid=120
Resolute Marine Energy Inc.	SurgeWEC	Full-scale	USA	www.resolute-marine-energy.com
SDE Energy	Sea Wave Power Plants	Full-scale	Israel	http://www.sdeglobal.com/
Seabased AB	Seabased	Full-scale	Sweden	www.seabased.com
Seatricity	Oceanus	Full-scale	UK	www.seatricity.net
Spindrift Energy	Spindrift	Small-scale	USA	http://www.spindriftenergy.com/
Trident Energy Ltd	PowerPod	Full-scale	UK	www.tridentenergy.co.uk
Voith Hydro Wavegen	Limpet OWC, Mutriku OWC	Full-scale		
Wave Dragon	Wave Dragon	Part-scale	Denmark	http://www.wavedragon.net/
Wave Energy Technology New Zealand (WET-NZ) ^b	WET-NZ	Part-scale	New Zealand	www.waveenergy.co.nz
WaveRider Energy	WaveRider Platform	Part-scale	Australia	www.waveriderenergy.com.au
WaveStar Energy	WaveStar	Part-scale	Denmark	www.wavestarenergy.com
Wedge Global		Part-scale	Spain	www.wedgeglobal.com
Wello OY	Penguin	Full-scale	Finland	www.wello.fi
WePTO	WePTO WEC	Part-scale	Denmark	www.weptos.com

^a Pelamis filed for administration in November 2014 ^b WET-NZ sold its technology to a US-based company in 2014

■ Companies shortlisted by IRENA

The JRC has identified 45 wave energy companies that have reached or are about to reach open-sea deployment of their technologies (Table 14).

Most R&D dedicated to wave energy takes place in Europe, with the US and Australia also proving fertile grounds for the development of wave energy technologies. As the sector moves towards commercialisation, there is a growing interest in developing wave energy technologies in countries that do not show a strong R&D component, such as Chile, which is investing in the development of ocean energy infrastructure (Whitlock 2014). An overview of the current global development is presented in Figure 20.

The global installed capacity of wave energy remains low, even compared to tidal energy. Most leading wave technologies are still at an advanced R&D stage, and only a few machines have sustained long operational hours, such as the Aquamarine Oyster (> 20000 h) and Pelamis (cumulative > 10 000 h) (Scottish Renewables 2014), or sustained operation in rough wave conditions, such as Wello Oy with waves greater than 12 m. Most of the developers are currently looking at improving the design and performances of their devices before progressing to array deployment. Even Carnegie, currently delivering the first commercial array off the coast of Western Australia, is upgrading its CETO5 240 kW device to the 1 MW-rated CETO6 (Herbert 2014).

The wave energy industry has seen some OEMs and utilities pull out of the sector, whilst others have reinforced their stakes. IRENA has highlighted the role of OEMs, which will be necessary for the development of utility-scale projects (IRENA 2014b). Bosch Rexroth has entered a collaborative agreement with different developers (Section 3.2.2); ABB is a

major stakeholder in Aquamarine Power (Corsatea & Magagna 2013); and DNCS in AW-Energy. Fortum currently holds a 13.6 % stake in Wello Oy, 8.6 % in AW-Energy, and has invested in the Seabased Sotenas Project, which is currently under construction (Fortum 2014a; Fortum 2014b; Fortum 2014c).

On the other hand, however, Voith Hydro stopped Wavegen to focus on tidal development, although its installations in Limpet and Mutriku are still in operation. Alstom has halted its wave energy R&D activities, while E.On abandoned its partnership with Pelamis. Pelamis has since struggled to attract major investment and filed for administration in November 2014 (Renewable Energy Focus 2014). In December, Aquamarine Power announced plans to downsize the company, whilst trying to keep its devices in operation at EMEC (BBC 2014a).

Recent announcements may affect the confidence of investors in the sector, whose growth is slower than expected. Wave energy technologies and markets still have much to prove on their path to commercial viability. Success in attracting future OEM investments will be dependent on the success of developers in improving performances, reducing costs and validating wave energy technologies.

3.3.2 Aiding development and deployment

The potential of wave energy has catalysed the interest of many countries that could exploit wave energy as a secure source of electricity in the future. In many instances, to facilitate the development of wave energy technologies, a number of dedicated test centres have been developed with the purpose of testing and demonstrating wave energy converters operating either stand-alone or in array



Fig. 20: Wave energy network. Purple markers: developers' headquarters; red markers: test sites and demonstration sites under development

configuration, with the addition of demonstration sites such as the Pico Power Plant in the Azores and Limpet in Scotland.

Europe alone accounts for 13 dedicated test sites developed or partially funded by local governments (SOWFIA 2011). However, many of these sites have not seen the installation of any devices, with most of wave energy deployments that have taken place thus far limited to a few locations. The majority of the installation so far has taken place within 10 km from the shore, contrasting with industry's hopes to develop WECs for offshore application (Section 3.2.3.1). For example, the Wave Hub, a wave energy test centre in the Southwest of the UK, was developed for wave energy array demonstration and to be the natural landing spot for developers who successfully conclude single WEC testing at EMEC. Despite being ready for device deployment since 2010, the Wave Hub has seen only the first installation of a WEC device, the Oceanus from Seatricity, in the summer of 2014 (BBC 2014b), after a number of announcements that have not materialised. It is important to highlight that the installation of the two Oceanus devices, which will be connected to the grid in 2015 after a year of monitoring, represents the most distant installation of a WEC from shore, and will provide developers and the wider industry an overview with regards to maintenance and survivability of the devices. Further installations are expected at the Wave Hub, as both Wello Oy and Carnegie have announced plans for deployment there (Herbert 2014). An overview of the infrastructure currently available in Europe is presented in Figure 21.

Funding mechanisms have also been developed in order to facilitate the deployment of single devices and of first-of-a kind array demonstrations. In some cases the funding mechanisms are the same as those developed for tidal energy, such as NER 300 or MEAD, with other specific funds made available for wave energy.

For example, in the UK, to facilitate wave energy development, the Scottish Government has devel-

oped the Marine Renewables Commercialisation Fund (MRCF) – Wave First Array Support Programme. The fund was made available when it was clear the leading wave energy technologies would not have been able to meet the requirements for MEAD funding. The aim of the Wave First Array Support Programme is to fund projects that will help wave energy technology to progress towards commercialisation, thus to ensure that wave demonstration arrays can be delivered in the 2016 to 2018 time period (Carbon Trust 2014). The necessity of specific funds to aid the uptake of wave energy technologies highlights how, currently, wave energy lags behind tidal in terms of maturity.

The West Wave project, a 5MW wave energy project off the west coast of Ireland, was awarded NER 300 funding in 2013. However, the project was withdrawn in early 2014 when it became clear that it could have not been completed with existing technologies by 2016. ESB International resubmitted an enhanced version of the West Wave project for a second NER 300 call, which was then awarded 23 m EUR. Similarly, the Swell project, a 5.6 MW wave energy array project off the coast of Portugal, was not awarded funds through the first NER 300 call but received 9.1 m EUR funding in the second call. The timely delivery of demonstration projects and the completion of the NER 300 projects will be fundamental to shaping the future market and inward investment for the wave energy industry in Europe.

Australia and the United States have both put in place mechanism to facilitate research, development and demonstration (RD&D) for wave energy projects. In 2013, the US Department of Energy (DOE) put in place the Marine Hydrokinetic System Performance Advancement, aimed at addressing PTO, control and structural design issues for wave energy converters (US DOE 2014). In Australia, the Australian Renewable Energy Agency (ARENA) has awarded over 110 m AUD in RD&D funds for wave energy. ARENA has also developed a series of guidelines to identify the risk for renewable technologies moving towards commercialisation (ARENA 2014a).

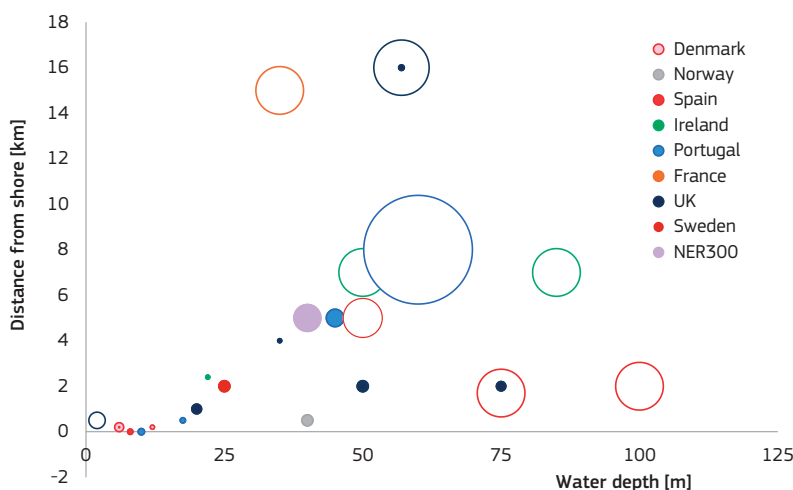

Fig. 21: Wave infrastructure in Europe. The size of the bubble refers to the capacity of installed project (filled circle) or the maximum site capacity (hollow circle)

Table 15: Wave energy development and deployment projects receiving EU or national support. Australian and US flagship projects are also included

Project Name	Location	Capacity	Funding Awarded	Funding Body	Expected Operation Date	Status and Updates
<i>Development projects</i>						
Pelamis & Aquamarine Power	Scotland	N/A	13 m GBP	MCRF Wave First Array Support Programme	N/A	Support for Device Development and Proving and Site Development Fast Track, aimed at accelerating the development and proving of the core device technology alongside the site development work necessary to progress towards first wave demonstration arrays in Scottish waters.
EMEC, Green Theme, Tension Technology International	Scotland	N/A	4.8 m GBP	MRCF	N/A	EMEC to implement a seabed monitoring pod. Green Theme to develop a cable-mounted device, aiding cable installation in fast flowing conditions. Tension Technology International to design a novel mooring system.
MHK System Performance Advancement	USA (Federal)	N/A	13 m USD	US DOE	In progress	Advanced R&D fund for PTO and structure optimisation and advanced WEC control
<i>Deployment projects</i>						
West Wave	Co. Clare, Ireland	5 MW	23.3 m EUR	NER 300/EU	30/06/2018	West Wave shortlisted Pelamis Wave Power and AW-Energy as potential technologies for installation.
Swell	Peniche, Portugal	5.6 MW	9.1 m EUR	NER 300/EU	01/01/2018	The project will receive upfront funding of 5.5m EUR on 01/01/2016.
Perth Wave Energy Project (Carnegie)	Perth, Australia	1 MW (up to 2 MW)	22.4 m AUD	ARENA, Western Australia Government	Construction completed	The Perth wave energy project may become the first wave energy array to become commercial, comprising four CETOS devices and expected by the end of 2014. Offshore construction is completed and device assembly has begun.
Carnegie CET06	Garden Island, Australia	3 MW	13 m AUD	ARENA	Announced	Arena awarded funds to Carnegie in June 2014. The total project value is of 46 m AUD.
BioPower Wave	Port Fairy, Australia	0.25 MW	5.6 m AUD	ARENA	Under development	Demonstration funds aim at installation of the pilot bioWave in 2015.
Oceanlinx	Victoria, Australia	1 MW	3.9 m AUD	ARENA	Closed 20/06/2014	Structural failures to the Oceaolinx device whilst it was towed to location.
Victorian Wave Power Station	Ocean Power Technologies (OPT)	19 MW	66.5 m AUD	ARENA	Closed 08/08/2014	OPT closed the project announcing that it was economically unviable.
<i>Test Centres</i>						
Atlantic Marine Energy Test Site (AMETS)	Belmullet, Ireland	20 MW	24 m EUR	Sustainable Energy Authority of Ireland (SEAI)	T.B.A.	A decision for foreshore lease application submitted in December 2011 was expected during early 2014.
Biscay Marine Energy Platform (BIMEP)	Armintza, Spain	20MW	20 m EUR (infrastructure)	Ente Vasco de la Energía (EVE), Spanish Energy Agency	Operational	The site was grid connected in 2014, and is currently operational.
EMEC	Orkney, UK	Six grid-connected berths	36 m GBP	Scottish Government, Highlands and Islands Enterprise, The Carbon Trust, UK Government, Scottish Enterprise, Orkney Islands Council.	Operational	Aquamarine Power, Pelamis, Wello and Seatricity are among the wave energy developers that have tested at EMEC.
Ocean Plug	Leira, Portugal	80 MW (up to 250 MW)	N/A	Redes Energéticas Nacionais (REN)	In progress	Development of the Pilot Zone to receive, in pre-commercial and proof of concept stages, generators of electricity (based on wave energy devices).
Oceanic Platform of the Canary Islands (PLOCAN)	Canary Islands, Spain	10 MW (up to 100 MW)	N/A	Spanish Government, Regional Government of the Canary Islands.	Operational	
Site d'Expérimentation en Mer pour la Récupération de l'Energie des Vagues (SEM-REV)	Le Croisic, France	8 MW	13.26 m EUR	Ecole Centrale de Nantes, Pays de la Loire, Loire-Atlantique	Operational	
Wave Hub	Hayle, UK	20MW	42 m GBP	DECC, Southwest Regional Development Agency	Operational	Seatricity installed the first two Oceanus2 devices in summer 2014.
■ Interrupted projects Sources: SOWFIA 2011; Carbon Trust 2014; US DOE 2014; ARENA 2014b						

By introducing the Commercial Readiness Index (CRI), a series of indicators to define the maturity of technology at higher TRLs and entering the demonstration phase, ARENA has tried to identify a system that would allow the reduction of risk for developers and funders in investing in emerging energy technologies, whilst developing specific funding mechanisms for the various stages of the technology development chain. The use of such instruments may prove useful in identifying the correct support scheme for wave and tidal energy. An overview of support schemes for wave energy is presented in Table 15.

In November 2014, The Scottish Government launched the Wave Energy Scotland Agency to coordinate and facilitate the development of wave energy in Scotland, which had significantly slowed down, and to ensure that wave energy intellectual property (IP) is maintained and further fostered. The aim would be to ensure that a least one wave energy technology reaches commercialisation by 2020–2025 (The Scottish Government 2014).

3.3.3 Future development

The wave energy industry is dedicating increased effort to improving current technologies, to identify and ensure long-term reliability and survivability of

devices, and to close the gap with other renewable energy technologies. Technology development and deployment will be of paramount importance to define the role of wave energy in the EU and global future energy markets. Since 2009 more than 100 projects have been announced in Europe alone, for a total installed capacity of 1200 MW; however, projects with a total of 770 MW have already been shelved, mainly due to economic uncertainties and the early stage of technology development (Figure 22).

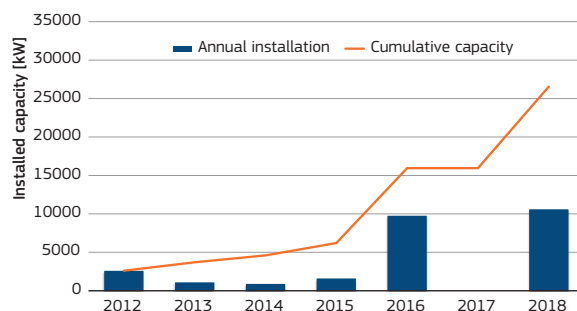

Fig. 22: Expected wave developments until 2018

Nevertheless technology and project developers are planning to develop arrays and commercial projects, although the bulk of expected deployments in the near future will consist mainly of single units and array demonstration projects. An overview of demonstration projects is presented Table 16.

Table 16: Upcoming wave energy demonstration projects

Project Name	Device	Capacity	Type	Expected Completion Date	Updates
Western Australia	Carnegie CET05	0.72 MW	Demo array	2014	The project is currently under construction, with the first device having started operations (ReNews 2014b).
EMEC – Oyster	Oyster 801	0.8 MW (up to 1.6 MW)	Single device/ Demo array	2015	Oyster 801 represents an improvement on the existing Oyster 800, deployed currently at EMEC. The two devices will be installed closely and connected to the same power station. Oyster 802 will be also installed, with the total array capacity expected to be 2.4 MW once completed. Oyster 800 underwent significant upgrades in summer 2014.
Sotenas	Seabased	10 MW	Array	2016	The construction of the array is currently underway with the first 10 devices out of a total of 340 already installed.
Wave Hub	Seatricity Oceanus	10 MW	Demo array	2016	The first Oceanus device was installed at Wave Hub in June 2014. Electricity generation will begin in 2015. Seatricity aims to deploy 60 devices at Wave Hub to a total of 10 MW. Oceanus devices are being fabricated in Falmouth.
Garden Island	Carnegie CET06	3 MW	Demo array	2016	Carnegie is currently upgrading its CET05 technology from 204kW to 1MW, and is expected to install in Garden Island in 2016.
Swell	Wave Roller	5.6 MW	Demo array	01/01/2018	16 Wave Roller devices should be installed off the coast of Peniche. The project has received NER 300 funds.
Wave Hub	Carnegie CET06	3 MW	Demo array	N/A	Carnegie was awarded a berth at Wave Hub in June 2014. They plan a 3 MW installation of its CET06 devices, with an option to expand up to 10 MW. The development of the project is to be carried out in parallel with the Garden Island 3MW demo array.
Wave Hub	Wello Oy Penguin	5 MW	Single device	N/A	In February 2014 Fortum signed a lease with Wave Hub for a berth. It later announced that it would be used for testing the upscaled version of the Penguin device, developed by Wello.
West Wave	Wave Roller Pelamis Oyster	5MW	Demo array	30/06/2018	In September 2014 it was announced that Wave Roller and Pelamis were shortlisted as the wave energy technologies to be deployed at the site.
Canary Islands	Langlee Robusto	0.5 MW	Demo array	N/A	Langlee has announced plans for the construction of devices in the Canary Islands and is also pushing forward testing and potential development in the Canary Islands, including a 500kW array.

A total of 45 MW of wave energy demonstration projects could be in the pipeline between now and 2020; however, the above target may reflect the ambitions of wave energy developers and is strongly dependent on technology performance and on securing the financial support to develop the projects.

The current situation, however, indicates that a more cautionary approach is needed, both in terms of deployment targets and technology readiness, placing strong emphasis on deployment goals that may help attract further investments. However, it is only through the demonstration of a reliable technology that the sector will be able to take off.

A more conservative estimate of the projects presented in Table 16 would see an expected capacity of 25.9 MW by the end of the decade, if projects that have already received funds go ahead, comparable to the forecast announced by BNEF (2014). In this case, deployments such as the Seatricity installations at Wave Hub are seen more as advance testing phases, and will be only connected to the grid in 2015. It is reasonable to expect that their expansion up to 10 MW of installed capacity will be dependent on the success of the current deployment phase.

The market for wave energy is poised to grow and mature in the near future, as project developers are acquiring leases for the deployment of wave energy farms, often jointly with technology developers and utilities. In the UK, The Crown Estate has already agreed to the lease of six wave energy demonstration zones and to 12 commercial project leases for a maximum potential of 650 MW.³ Support activities aimed at preparing the future market and removing non-technological barriers for wave energy are taking place, addressing legislative, environmental and licensing barriers. These issues are cross-sectoral and can offer opportunities for knowledge transfer, with concerted efforts to identify optimal solutions. In response, EU funds have been directed to address wave energy-specific non-technological barriers such as the WavePlam and SOWFIA projects. Both projects were funded by the Intelligent Energy Europe (IEE) programme, which was not aimed at R&D but at building capacity for energy technologies.

Preparatory work is currently underway to ensure that policy, licensing and financial tools will be ready to support the growth of the wave energy market, once the technology is ready to play a significant role in the integrated European energy system. However, if Europe is to take advantage of the potential benefits associated with wave energy, policy mechanisms should focus on facilitating technology research, development and demonstration at full scale, to unlock the development of early pre-commercial arrays and the establishment of a wave energy market (Magagna *et al.* 2014).

3.4 Economic Aspects and Cost Components

The long-term goal for wave energy is to become cost competitive and to provide an alternative to other RESs and conventional energy sources as a reliable energy technology feeding to the European Energy system. The following paragraphs present the ETRI parameters that the JRC has identified for different current and future wave energy technologies (ETRI 2014). It shall be highlighted that given the nascent stage of wave energy technology, the reported values for ETRIs are estimates retrieved from existing literature and expert judgement. As such, these estimates contain considerable uncertainties. Many factors affect these values as the technologies mature, in terms of both economic and technical performance.

In the following subsections, an overview of the wave energy cost components, future costs predictions and estimates of the levelised cost of energy (LCOE) are given.

3.4.1 CAPEX and cost components

Through a review of the existing data available, the different cost components to be included in the CAPEX estimate for wave energy have been identified as follows:

- Civil and structural costs
- Major equipment costs
- Balance of plant costs
- Electrical and I&C supply and installation
- Project indirect costs
- Development costs.

An overview of the CAPEX breakdown is presented in Figure 23. The identification of cost components is essential to help identify strategies for cost reduc-

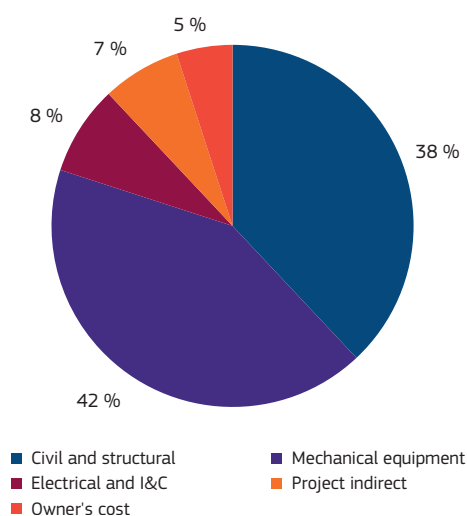

Fig. 23: CAPEX breakdown for wave power. Source: ETRI 2014

³ This excludes leases awarded to E.On, since it has discontinued its wave energy activities

tions through concerted effort, increased supply chain pooling, and increased efficiency and reliability at the subcomponent level. Similar to tidal energy, the main components of CAPEX are mechanical equipment costs, followed by civil and structural costs.

3.4.2 Future power ratings

The future power ratings of wave energy are highly uncertain; hence, a range is given up to 2050. It should be noted that most of the current literature provides cost information for 10 MW arrays once 10 MW of existing capacity is already in place. Thus, it is likely that the current CAPEX and cost may be higher than that publicly available. For this reason, the upper limit for current CAPEX estimates are used in the near term, while long-term estimates align with future predictions. An overview of techno-economic data of current and future projections is presented in Table 17.

3.4.3 LCOE predictions

Figure 24 presents LCOE predictions for wave

energy technology. LCOE was calculated using the ETRI parameters data as reported in Table 17 (ETRI 2014), taking into account a 12% CAPEX learning rate. The reference LCOE associated with wave energy currently ranges between 70 c EUR/kWh and 105c EUR/kWh. It can be expected that wave energy technologies could become competitive once approximately 2.5–10 GW of cumulative capacity has been installed, using 10 c EUR/kWh as the reference LCOE for mature RESs, in line with the findings of SI Ocean (SI Ocean 2013b). The convergence of wave energy to given LCOE depends not only on resource availability but also on the ability of the sector to identify common solutions and broader design consensus, which will unlock economies of scale. The worst-case scenario for the wave energy sector would see the technologies becoming competitive only after more than 20 GW of capacity has been installed.

Actions and activities that are currently being undertaken to facilitate the commercialisation of wave energy technologies will be discussed in Chapter 5.

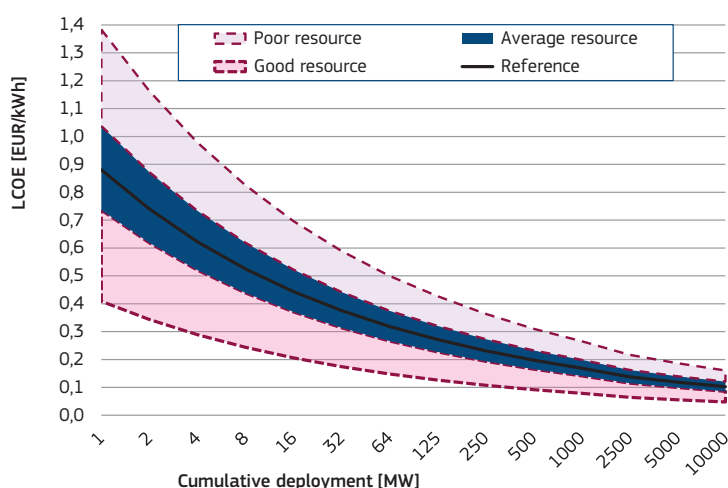

Fig. 24: LCOE predictions for wave arrays. Source: JRC, based on ETRI 2014

Table 17: Techno-economic data for wave energy

	Unit	2010	2020	2030	2040	2050
Technical						
Net electrical power ^a	MWe	1–5	5–20	30–40	40–50	50–400
Max. capacity factor	%	36	45	47	47	50
Avg. capacity factor	%	20	23	28	32	36
Technical lifetime	Years	20	20	20	20	20
Costs						
CAPEX ref.	EUR ₂₀₁₃ /kWe	9080	5790	4480	2700	2300
CAPEX low	EUR ₂₀₁₃ /kWe	7590	5060	3890	2560	2050
CAPEX high	EUR ₂₀₁₃ /kWe	10700	6390	5490	2650	2560
Quality of CAPEX estimate				Low		
CAPEX learning rate	%	12	12	12	12	12
FOM	% of CAPEX ref.	3.6	4.1	4.7	5.8	5.8
Evolution						
Max. potential	GWe	0.03	0.19	1.9	2.0	3.2

^a Current estimates for wave energy plants focus on the development of 10 MW arrays; projects for up to 140 MW have been announced but no clear timescale is currently available. Source: ETRI 2014

4 OVERVIEW OF EMERGING TECHNOLOGIES

Several other types of ocean energy technology are currently being developed. An overview of the most promising technologies, ocean thermal energy conversion and salinity gradient, will be given in the following sections.

4.1 Ocean Thermal Energy Conversion

Ocean thermal energy conversion captures the temperature difference between cooler deep and warmer shallow ocean water to produce electricity. OTEC needs a temperature difference of about 20°C or more (Fujita *et al.* 2012; Semmari *et al.* 2012). Since water temperatures of 4°C can be found in the bathyal zone at about 1 km depth, ocean surface water temperatures should reach 25°C, conditions that can mainly be found in tropical latitudes (Lewis *et al.* 2011; CSIRO 2012). Compared to other ocean energy technologies, OTEC has some advantages. It can provide continuous base-load power, and it can also provide fresh water for irrigation or drinking water and cold water for refrigeration (IRENA 2014c).

Resources for ocean thermal energy conversion are larger than for any other type of ocean energy. It is estimated that between 30000 and 90000 TWh/year of power are extractable without having negative impacts on the thermal characteristics of the oceans (Charlier & Justus 1993; Pelc & Fujita 2002; Lewis *et al.* 2011; Semmari *et al.* 2012; Rajagopalan & Nihous 2013). Main resources can be found in the area between 30° S and 30° N, which means in tropical seas (Nihous 2007; Nihous 2010). Figure 25 shows the temperature difference between water depths of 20 m and 1000 m, and the potential of areas showing a temperature gradient of more than 20° C. Hence, the technology offers little potential in European continental waters.

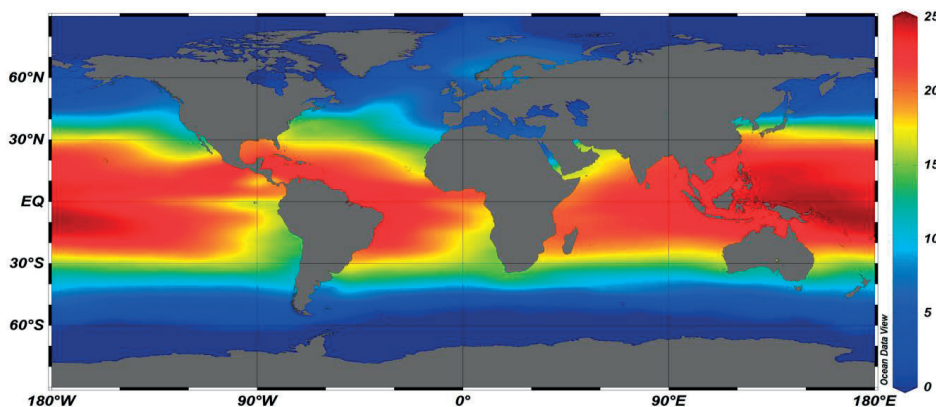

Fig. 25: OTEC resources: Temperature difference between 30 m and 1000 m depth. Source: World Ocean Atlas 2013a, graph produced with Ocean Data Viewer

Three main types of OTEC can be differentiated: open-cycle, closed-cycle and hybrid systems. In an open-cycle plant, warm surface water is flash evaporated and drives a turbine (Figure 26). Cool water is used to condense the vapour again. The condensed desalinated water can be used for various purposes (e.g. drinking water, irrigation). The cold water that has been pumped from the sea can feed air-conditioning systems after it has been used in the condenser. In addition, the cold seawater can also be used in aquaculture, since it is rich in nutrients.

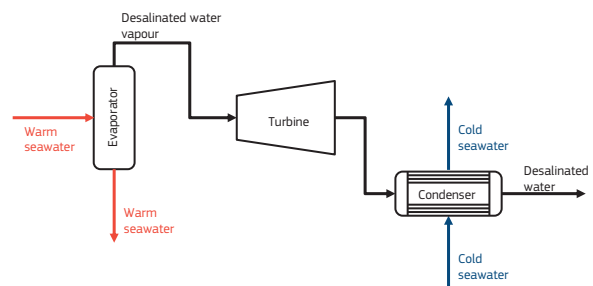

Fig. 26: Simplified open-cycle OTEC process flow diagram

Closed-cycle OTEC plants use a working fluid with a low boiling point. The vapour drives a turbine and is condensed using cold seawater (Figure 27). In general, refrigerants or ammonia can be used as the working fluid, but water–ammonia mixtures are also used (Kalina cycle). Closed-cycle plants are more efficient compared to open-cycle plants (Charlier & Justus 1993).

Hybrid OTEC systems consist of a combination of open and closed cycles. Several concepts have been discussed; one in which the steam from the flash evaporation is the heat source to drive the closed cycle, and one in which the discharge from the closed cycle is used to produce desalinated water (Vega 2002; IRENA 2014c).

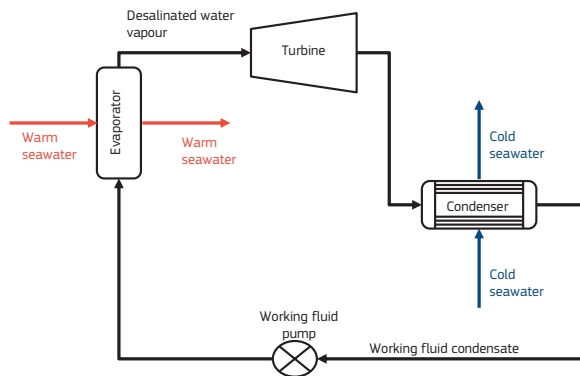

Fig. 27: Simplified closed-cycle OTEC process flow diagram

OTEC plants can be based onshore (land-based and near-shore) or offshore. The advantages of land-based and near-shore plants are the ease of maintenance and the fact that they could be used to provide desalinated water or other services (e.g. seawater air-conditioning). No mooring is needed, and there is no need for marine power cables. Disadvantages are the need for a long cold-water intake pipe, and probably limited availability of thermal resources (Devis-Morales *et al.* 2014). Onshore OTEC plants may also have adverse effects on the local economy, due to land use, and may impact tourism. Offshore platforms need expensive anchoring or mooring systems and have to withstand harsh conditions. Transport of energy to the land is difficult and requires marine power cables, which may be expensive and difficult to maintain.

4.1.1 Technology development and status

Early studies on OTEC can be tracked back to the nineteenth century (D'Arsonval 1881; Claude 1930; Anonymous 1930; Finney 2008). Major research activities were started during the 1970s, triggered by the oil crisis.

The Japanese Sunshine Project, launched by the Ministry of International Trade and Industry, aimed to develop new energy sources and also included OTEC. Saga University built several pilot plants, able to produce about 1 kW of energy. In 1980, another 50 kW closed-cycle pilot plant was built by Saga University. Research in 1978 in the US culminated in the construction of a 50 kW 'Mini-OTEC' plant, which was a closed-cycle system located on a raft. This plant was the first OTEC plant that generated net electricity during its three months of operation. A 100 kW plant was built in 1981 on Nauru by the Tokyo Electric Power Company, followed by a 210 kW open-cycle plant, built by the Pacific Institute for High Technology Research in Hawaii (Avery & Wu 1994; Vega 2002). A 1 MW floating closed-cycle OTEC plant was constructed in India; however, problems with the cold-water piping prevented a successful test (INSA 2001).

Research and development was resumed in the US in 2006, when the US Office of Naval Research

funded a study to assess hydrogen production at floating OTEC plants (Meyer *et al.* 2011). In 2011, an OTEC heat exchanger test facility was installed in Hawaii. The OTEC test facility is equipped with deep-water pipelines and pump stations, and uses ammonia in a closed cycle. A 100 kW turbine and generator has been installed during 2014 and will be tested in the future (OTEC News 2013; Roll Call 2014; NELHA 2014).

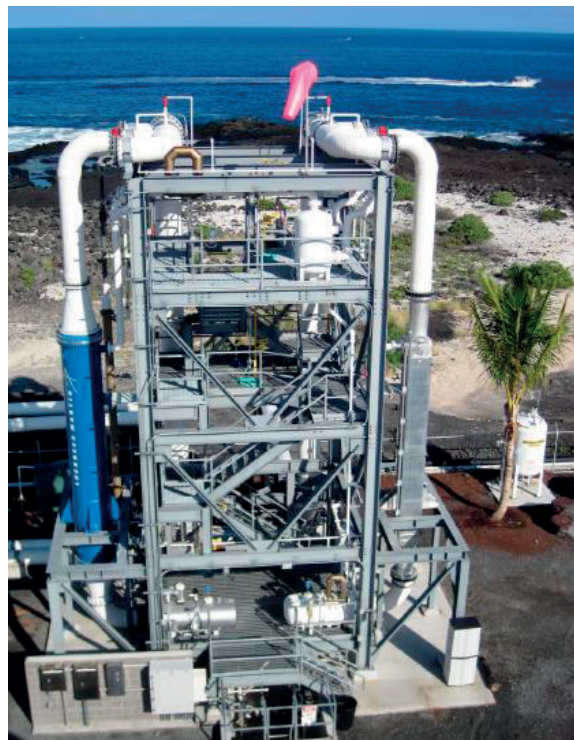

Fig. 28: Heat exchanger test facility at NELHA. Source: Meyer *et al.* 2011

In 2013, a new OTEC plant was built in Japan by Saga University at Kume Island. The demonstration plant consists of two units of 50 kW each and uses the refrigerant R134a as the working fluid (OTEC Okinawa 2014). The plant will be used to assess impacts of variable weather and seawater conditions on plant efficiency. In South Korea, a 20 kW pilot plant was built in 2013, and a 200 kW facility is planned for 2014 (OTEC News 2014a). Currently, these are the only two OTEC plants in operation worldwide.

At the moment, several larger OTEC projects are being planned and discussed. An overview of these projects is given in Table 18. Most of the proposed projects are of about 10 MW in size. Most developers see them as a first step, which will then be followed by a scaling up to plants of about 100MW of capacity.

4.1.2 Technical challenges and current research

In general, OTEC plants can rely on already-developed and proven technology from conventional steam power plants (e.g. pumps, turbines, heat exchangers). Due to the small temperature gradient,

an ideal OTEC cycle might reach a theoretical efficiency of about 8 %. In practice, only 3–4 % seems realistic, due to heat losses and system inefficiencies. Large quantities of seawater have to be pumped for the heat transfer. It is estimated that 4 m³ of warm and 2 m³ of cold seawater per second are required for 1 MW net electricity (Vega 2002).

While many marine components such as floating platforms or mooring needed are available from other offshore industries (e.g. oil & gas), some engineering challenges still exist. Pipes with large diameters (4 m and greater) are needed to transport the cold seawater to the OTEC plant. In addition, the hostile environment leads to quick corrosion of pipe-work. Other technological problems that have to be overcome are biofouling, the sealing of components, and marine power cabling (Vega 2002, Coastal Response Research Center 2010, CSIRO 2012).

Since heat exchangers constitute a major part of the investment costs of an OTEC plant and their performance have a great influence on overall system efficiency, R&D efforts have been and still are focussing on heat exchangers. Accumulation of microorganisms on surfaces can occur in heat exchangers which leads to a decrease of heat exchanger efficiency, especially when a thin layer of biofilm is formed and heat conductivity is reduced (Murthy *et al.* 2004). Already in the 1980s it has

been shown that chlorination might inhibit microbial growth in heat exchangers (Fava & Thomas 1978, ; Berger & Berger 1986). Different materials for heat exchangers have been tested in light of preventing biofouling (Nickels *et al.* 1981).

Another key part of OTEC plants is the cold-water pipe. It has been proven that cold-water pipes for 10 MW plants can be constructed and operated (Vega 2002). The main material used and tested so far is fibre-reinforced plastic (FRP) in pipes for floating farms. For onshore plants, segmented pipes from steel, concrete and FRP can be used.

New working fluids also offer the possibility to improve the thermal efficiency of OTEC plants (Yoon *et al.* 2014). Yang and Yeh (2014) optimised the operational conditions with respect to maximising net efficiency and minimising the heat transfer area (which allows cost reductions). Yuan *et al.* (2013) tested different operating conditions in order to optimise working-fluid flow rate. A new thermo-dynamic cycle was proposed by Semmari *et al.* (2012) using a work-transfer liquid (which can be water or oil) as a liquid piston, driving a hydraulic turbine such as a Francis turbine. Since a hydraulic turbine can be smaller compared to a steam turbine, the concept allows for cost savings. Another novel concept was presented by Gilmore *et al.* (2014): a floating plant far from the coast that produces energy, which is

Table 18: Planned and proposed OTEC projects worldwide

Location	Power Output	Characteristics	Developer/Owner	References
Hawaii	1 MW	The plant will be located onshore at NELHA. Closed cycle with ammonia. Environmental assessment completed. Lease negotiations are ongoing.	OTEC International LCC	(Big Island Video News 2012; OTI 2013; OTI 2014)
Diego Garcia	13 MW	Project planned for the US Navy on the Diego Garcia island in the Indian Ocean. Plant should also provide drinking water. Currently put on hold.	Ocean Thermal Energy Corporation	(OTE 2014a)
Bahamas	5–10 MW	MoU signed with Bahamas Electricity Corporation (BEC), and Power Purchasing Agreement (PPA) has been signed with a utility company.	Ocean Thermal Energy Corporation	(OTE 2014b)
Hawaii	10 MW	Closed-cycle OTEC pilot system, to be expanded to a commercial project of 100 MW. Project was stopped.	Lockheed Martin & Makai Ocean Engineering	(IRENA 2014c)
Hainan	10 MW	Onshore plant planned for a big resort on the Hainan island. Contracted by Reignwood Group. Construction is expected to start in 2014, with completion in 2017.	Lockheed Martin	(Patel 2013; IEEE Spectrum 2014; IRENA 2014c)
Virgin Islands		MoU signed for performing feasibility studies for onshore OTEC/SWAC/desalinated water plants.	Ocean Thermal Energy Corporation & DCNS	(OTE 2014b)
Reunion	1.5 MW	R&D agreement signed to perform a feasibility study on a 1.5MW pilot plant. A land-based prototype was built in 2012, and testing is ongoing.	DCNS	(WEC 2013; DCNS 2014b; OTEC News 2014b)
Martinique	10.7 MW	Floating demonstration plant with a closed-loop Rankine cycle. Nominal capacity 16 MW. Funding of 72 m EUR granted under NER 300 programme. Entry into operation foreseen in 2016.	DCNS & Akuo Energy	(WEC 2013; Commission Decision C(2014) 4493 2014; OTEC News 2014b; OTEC News 2014c)
Tahiti		An agreement to perform a feasibility study was signed, and the study was finalised in 2014.	DCNS	(WEC 2013; DCNS 2014b)

then transported to the coast in the form of energy carriers such as ammonia, liquid hydrogen or methanol.

4.1.3 Economic and market aspects

The greatest challenge the OTEC sector faces today is high capital costs, and the associated problems with getting access to finance. So far, cost estimates stem from feasibility studies and desk-based research (Table 19).

The LCOE for OTEC found in the literature is higher than the LCOE for conventional power plants and is comparable to other renewables. The same holds true for CAPEX, where OTEC plants show considerably higher values compared to conventional fuels (e.g. 875 EUR/kWh for a combined-cycle gas turbine (ETRI 2014)). CAPEX for other renewables, in general, is also lower than for OTEC (e.g. 1,400 EUR/kW for onshore wind, 3,470 EUR/kW for offshore wind, 1150 EUR/kW for solar panels and 2200 EUR/kW for hydropower (ETRI 2014)).

CAPEX can be split into different cost items, such as offshore equipment (e.g. platforms, moorings, seawater pipes), process equipment (e.g. heat exchangers, working-fluid pumps) and electrical equipment (turbines, generators, power cables) (Bluerise 2014). The most expensive components of an OTEC plant are the platforms, heat exchangers and pipework. The respective share of each of the components depends on the specific plant layout and type, but can reach up to 50 % for heat exchangers, in the

case of large-scale plants, and 50 % for pipework, in the case of small land-based plants (IRENA 2014c). An example for disaggregated CAPEX is shown in Figure 29, for a 10 MW floating closed-cycle plant.

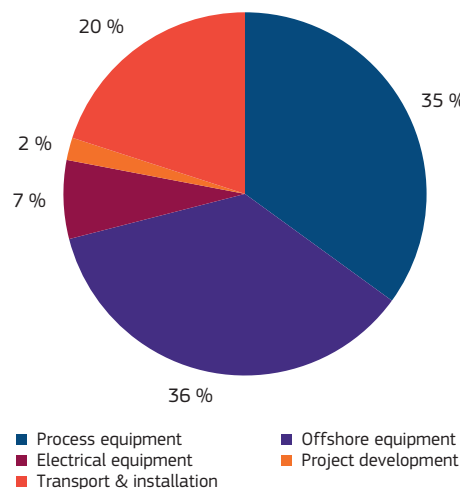

Fig. 29: Disaggregated CAPEX for a 10 MW OTEC plant. Source: Bluerise 2014

Annual operation and maintenance costs (OPEX) are estimated to be small compared to CAPEX. Annual OPEX is estimated to be about 1–3 % of capital costs (Vega 2002; IRENA 2014c).

Economic performance of an OTEC plant will depend very much on its specific configuration and location. Promising markets are island countries and remote islands in tropical regions, due to provision of additional services such as air-conditioning or fresh water production.

Table 19: Cost estimates for OTEC plants: CAPEX and LCOE

CAPEX [EUR/kW] ^a	LCOE [EUR/kWh] ^a	Plant Description	Assumptions	Reference
3100–9200	0.05–0.16	100 MW closed-cycle, floating, only electricity production	1 % maintenance, interest rate 10 %, cost depending on distance (10 km to 400 km)	(Vega 2002)
9100	-	40 MW closed-cycle plant with four units, near-shore (Hawaii)	430 m USD total investment costs (16 % heat exchangers, 36 % pipes, 24 % platform)	(SERI 1989)
5400	-	Open-cycle onshore plant	No details given, size unknown	(SERI 1989)
6000–7500	0.12–0.15	100 MW closed-cycle	No details available	(Cohen 2009)
3360–4480 6870 8200–17100	0.05 (best case)	40 MW closed-cycle 40MW hybrid 1–10 MW open-cycle	Different concepts, including floating and onshore. Revenue from desalination by open-cycle and hybrid included	(Cavrot 1993)
7500–11200	0.09–0.13	100–400 MW closed-cycle plants	30-year lifetime, capacity factor (CF) of 95–97 %, 4 % discount rate	(Martel <i>et al.</i> 2012)
10000	0.08	50 MW plant	CF of 90 %, no details given	(Straatman & van Sark 2008)
4800–18400	0.10–0.75	20 MW closed-cycle floating plant	Based on low–medium–high estimates. Details for cost breakdown available	(Upshaw 2012)
6000	0.11	75 MW closed-cycle, floating, 6 miles off shore (Puerto Rico)	No details given	(Plocek <i>et al.</i> 2009)

^a For references in USD, conversion to EUR was performed assuming an exchange rate of 1 EUR = 1.34 USD

The main companies involved in OTEC projects are shown in Table 20. The main actors are developers, ranging from big corporations such as Lockheed Martin and DCNS, coming from the marine and defence sectors, to companies specialising in OTEC such as the Ocean Thermal Energy Corporation or OTEC International. Some actors from other offshore industries are now also active in the market, for example SBM Offshore, which supplies offshore floating and mooring solutions. Most companies involved in OTEC are based in the US and the European Union.

4.2 Salinity Gradient

Salinity gradient power or osmotic power uses the difference in salt concentration between seawater and fresh water to produce electricity. In principle, salinity gradient energy converters could produce base-load electricity. Resources can be found everywhere in the world where fresh water is discharged into seawater (Figure 30). River mouths are the most promising locations for salinity gradient plants

(Lewis *et al.* 2011). Salinity gradient resources are great: it is estimated that about 1300 to 2000 TWh of electricity could be produced annually (van den Ende & Groemann 2007; Skilhagen *et al.* 2008; Skråmestø *et al.* 2009; Achilli & Childress 2010).

Currently, two main types of technology to exploit this energy potential are considered: reverse electro-dialysis (RED) and pressure-retarded osmosis (PRO), with both types being based on ion-specific membranes (Lewis *et al.* 2011).

RED is the reverse of the electro-dialysis process used to produce fresh water from brackish water. It needs two different membranes: anion and cation exchange membranes that are selectively permeable for specific ions (Post *et al.* 2007). Salt water and fresh water are separated by alternating membranes (Figure 31). In consequence, sodium ions from the salt water will permeate through the cation exchange membrane, and chloride ions will pass through the anion exchange membrane. A potential difference is created that can be used as electrical energy (van den Ende & Groemann 2007).

Table 20: Overview of main players in the OTEC sector

Name	Country	Type	Description/Current Activities	Website
Bell Pirie Power	UK/Philippines	Technology developer/Owner	Developing a 10 MW pilot plant in Zambales, The Philippines	www.bellpirie.com
Bluerise	NL	Developer/Consultant	Specialises in OTEC and SWAC. Currently running a small demonstration plant	www.bluerise.nl
DCNS	FR	Developer	Naval defence company. Operates a land-based prototype in Ré-union. Technology supplier for the 16 MW NEMO plant project	www.dcnsgroup.com
Energy Island	UK	Consultant	Feasibility studies, develops project proposals, engineering designs	www.energyisland.com
Lockheed Martin	US	Developer	Involved in OTEC since the 1970s. Developed the miniOTEC plant. Recently signed a contract with Reignwood Group to design a 10MW plant	www.lockheedmartin.com
Makai Ocean Engineering	US	Developer	Ocean engineering company focussing on OTEC, SWAC, pipelines and submarine cables. Currently installing a turbine on the heat exchanger test facility in Hawaii.	www.makai.com
Ocean Thermal Energy Corporation	US	Developer	Active in OTEC and SWAC. Will build a SWAC facility in the Bahamas and signed MoUs to design, build and operate OTEC/SWAC plants in the future	www.otecorporation.com
OTEC International	US	Developer	Worked in OTEC for more than 40 years, holds many patents. Several projects in pipeline	www.oteci.com
SBM Offshore	NL	System and service provider	Specialises in floating platforms and mooring systems. Performs R&D in the area of wave energy and OTEC	www.sbmoffshore.com
Xenesys	JP	Developer	Focussing on OTEC, waste heat and desalination. Runs an R&D centre and heat exchanger production facility in Imari, and operates the Kinawa pilot plant	www.xenesys.com

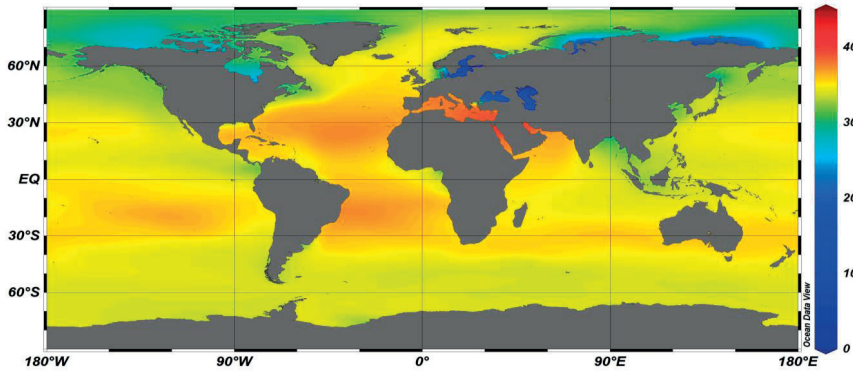

Fig. 30: Salinity gradient resources: Salinity at surface level. Source: World Ocean Atlas 2013b, graph produced with Ocean Data Viewer

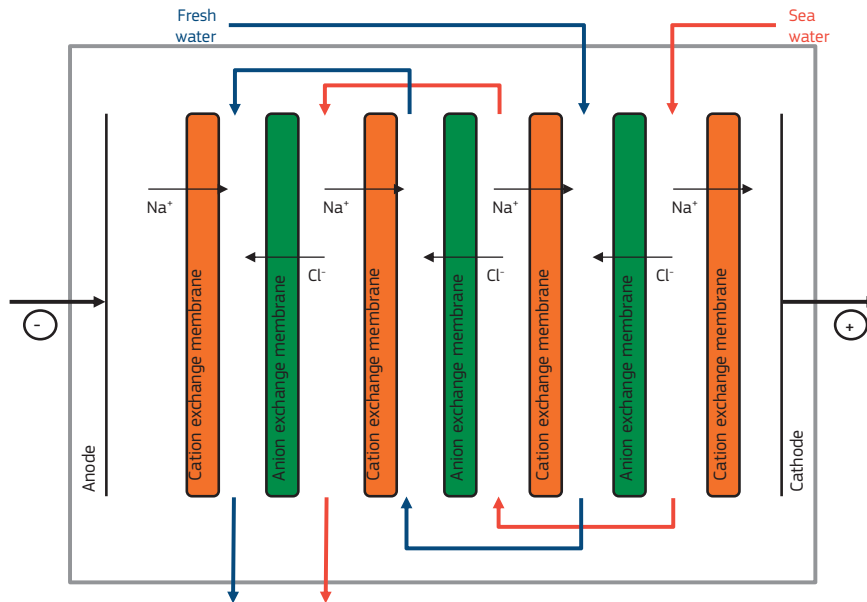

Fig. 31: Simplified RED process flow diagram. Sources: van den Ende & Groemann 2007; Post et al. 2007

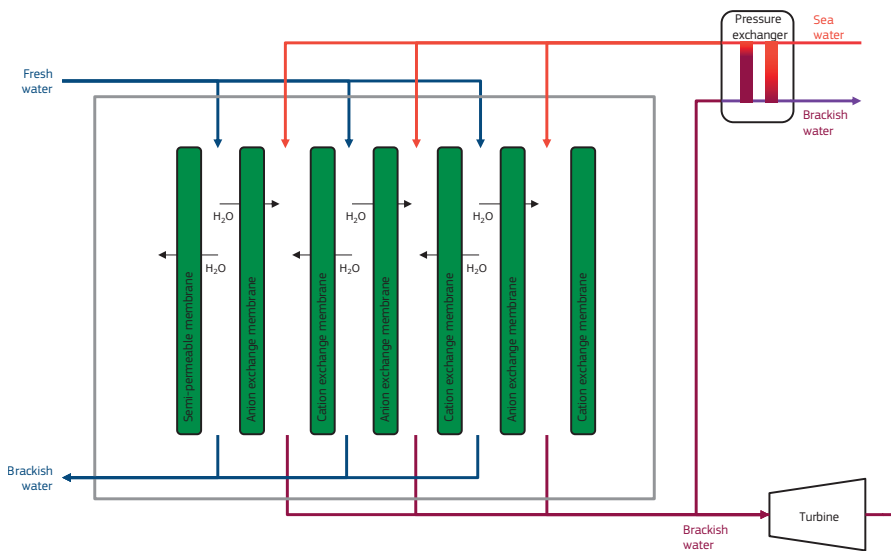

Fig. 32: Simplified PRO process flow diagram. Source: Post et al. 2007

Pressure-retarded osmosis also brings salt water and fresh water in contact by a membrane. The membrane is permeable for water but not for salts. An example of a PRO process is shown in Figure 32. Salt water is pressurised to 1.2–1.3 MPa. Fresh water migrates through the membrane and increases the volumetric flow of high-pressure water. One third of the resulting brackish water can be used in a hydro-turbine to generate electricity, whilst the remainder is used in a pressure exchanger to increase the pressure of the incoming salt water (Lewis *et al.* 2011).

Besides RED and PRO, other technologies are currently being investigated. Vapour compression exploits the difference in vapour pressure between salt water and fresh water to produce electricity. In principle, fresh water is evaporated in a vacuum and condensed in salt water (Olsson *et al.* 1979; Olsson 1982). Advantages of this method are that it does not need membranes and that it is a very reliable technology (Charlier & Justus 1993; Jones & Finley 2003).

Another idea, developed recently by Brogioli, is to charge up electrodes in contact with saline water and then discharge them in fresh water, and to repeat the cycle continuously (Brogioli 2009). When in contact with saline water, some ions will diffuse out of the capacitor, which reduces capacitance. To keep the ratio of charge to capacitance constant, voltage increases. It is expected that this capacitive method is competitive with membrane methods. Currently, the FP7 project Capmix further develops the method, aiming at a power density of 100 W/m³ and an energy recovery of 70 % (Capmix 2014).

4.2.1 Technology development and status

The concept of using salinity gradients to produce energy was proposed in the 1950s by Pattle (Pattle 1954). Later, in the 1970s, PRO was developed further by Loeb (Achilli & Childress 2010), who published first results from experimental studies. In the 2000s, resource assessments were performed by Statkraft and the Foundation for Scientific and Industrial Research, at the Norwegian Institute of Technology (SINTEF), and Seppälä published papers on modelling and possible PRO system configurations (Achilli & Childress 2010). Statkraft also examined membrane properties and behaviours for PRO membranes (Skilhagen *et al.* 2008; Gerstandt *et al.* 2008; Thorsen & Holt 2009). In 2009, the first PRO pilot plant, with a designed capacity of 10 kW, was opened by Statkraft in Norway (Power Technology 2014). In December 2013, Statkraft announced it was to stop the pilot plant and all development activities related to salinity gradient energy (Statkraft 2014).



Fig. 33: Statkraft's PRO pilot plant in Tofte, Norway.
Source: Skråmestø *et al.* 2009

More recently, a RED pilot plant that will generate 50 kW was built in the Netherlands (The Daily Fusion 2014). It was announced that infrastructure and building have been completed, and first trials begun (Redstack 2014). The plant can process 220 m³ of water per hour, and it is planned to increase throughput to 100000 m³ in the following years (Figure 34).

Currently, we are not aware of any other ongoing salinity gradient projects. Activities have been



Fig. 34: RED pilot plant at Afsluitdijk, Netherlands.
Source: The Daily Fusion 2014

proposed in, among others, Canada, Singapore and South Korea (IRENA 2014d).

4.2.2 Technical challenges and current research

Current research in salinity gradient energy focusses mainly on membranes, since they are key components for both PRO and RED applications. Large membranes are required, for example, Gerstandt *et al.* (2008) state that 200000 m² of membrane surface are needed for a 1 MW plant. The main goals in R&D are to improve membrane performance and to reduce maintenance and replacement needs. PRO membranes should allow for high water permeability and low permeability for salts. In addition, the membrane skin should exhibit an osmotic transport mechanism. The structure of the membrane should prevent build-up of salt concentrations inside the membrane (Gerstandt *et al.* 2008). Ion exchange membranes used in RED should feature a high ion exchange capacity and selectivity (Hong & Chen 2014).

Current studies investigate which membrane properties are crucial for performance (Güler *et al.* 2013), and membrane material selection (Fu *et al.* 2014). Research aims at improving membrane structure and chemistry (Buonomenna 2013; Cheng *et al.* 2013; Patel *et al.* 2014; Zhou *et al.* 2014), sometime using membranes already commercially available. Other researchers develop new types of membranes, such as hollow-fibre or high-performance thin-film composite (TFC) or high-performance ion-exchange membranes (Chou *et al.* 2012; Han *et al.* 2013; Hong & Chen 2014). Other work relates to the design and production of the modules that contain the membranes (She *et al.* 2013; Güler *et al.* 2014). R&D synergies exist, since membranes are also used in other applications, including water treatment, fuel cells, electrodialysis, desalination and gas separation (Güler *et al.* 2013; Hong & Chen 2014).

Another area of research is biofouling, which leads to performance losses (Yu *et al.* 2013). For example, Emadzadeh *et al.* (2014) developed a thin-film

nanocomposite (TFN) substrate that allows reduction of fouling. Zhou *et al.* (2014) modified commercially available membranes to improve performance and reduce biofouling. Other technical challenges that have to be overcome include the pre-treatment of water and the large-scale manufacturing of membranes (IRENA 2014d).

4.2.3 Economic and market aspects

Salinity gradient has only been used on a small scale, up to a capacity of 50 kW. Cost figures for commercial installations are thus not available and have to be estimated (Lewis *et al.* 2011; Vermaas 2013). Membranes constitute a major fraction of CAPEX for RED and PRO systems (80 % of costs (IRENA 2014d)), since currently there are no membranes commercially available for salinity gradient energy production. Besides membranes, other components such as vessels and turbines, and other equipment are available off the shelf (IRENA 2014d).

Table 21 shows some cost estimates for CAPEX and LCOE for salinity gradient power plants. Investment costs of salinity gradient power is higher than for other renewable energy systems, but the capacity factor will be significantly higher, since 8000 hours of operation per year does not seem unrealistic (Skråmestø *et al.* 2009; Lewis *et al.* 2011). Vermaas (2013) mentions that LCOE for salinity gradient in the Netherlands will be lower compared to solar power and slightly more expensive than wind power, but also stresses that salinity gradient will produce base-load power, in contrast to solar and wind, which rely on fluctuating resources.

Since the key component of salinity gradient power plants is the membrane, the most active companies in the field are membrane developers (Table 22). Other players are small start-up companies specialised in certain areas such as PRO or RED. Also, industrial companies from the desalination and water treatment sectors are becoming more active in salinity gradient power.

Table 21: Cost estimates for salinity gradient plants: CAPEX and LCOE

CAPEX [EUR/kW] ^a	LCOE [EUR/kWh] ^a	Plant Description	Assumptions	Reference
11300	0.12–0.27	5.4–10 MW PRO plant	Different infrastructure costs and salt concentrations assumed depending on location	(Molenbroek 2007)
9630	0.08	10 MW RED plant, 5.6x10 ⁶ m ² membrane	Based on information from Red Stack	(Molenbroek 2007)
n.a.	0.16–0.18	No details available	Membrane price reduced to 4.3 EUR/m ² and below	(Vermaas 2013)
n.a.	0.05–0.09	No details available	Estimates from Statkraft	(Ravilious 2009)
n.a.	0.05–0.10	Forecast for 2030	Estimates from Statkraft	(Lienard & Neumann 2011)
n.a.	0.09–0.28	Hybrid plant and standalone plant (4 MW)	Lowest costs for hybrid (brine from desalination), highest for standalone	(Stenzel 2012)
n.a.	0.08–0.15	5 MW RED plant in 2020	Upscale forecast: 50 kW in 2017, 5 MW in 2020	(IRENA 2014d)
n.a.	0.11–0.22	5 MW PRO plant in 2020	Upscale forecast: 2 MW in 2017, 5 MW in 2020	(IRENA 2014d)
5000	0.08	200 MW RED plant	Cost estimate based on a small 200 kW pilot unit	(Post et al. 2010)
4200–5500	0.09–0.13	20 MW RED plant	4 N brine solution, costs in USD ₁₉₇₈ , 20-year lifetime, costs depend on membrane resistance	(Lacey 1980)

^a For references in USD, conversion to EUR was performed assuming an exchange rate of 1 EUR = 1.34 USD

Table 22: Overview of some players in the salinity gradient sector

Name	Country	Type	Description/Current Activities	Website
Fujifilm	JP	Membrane producer	Photography and imaging company. Membranes section focusses on desalination and ion-exchange membranes for RED. Supplies the membranes for the 50 kW pilot plant at Afsluitdijk, Netherlands	www.fujifilmmembranes.com
Nitto Denko	JP	Membrane producer	Chemical company. Membrane products for a range of applications including desalination. Collaborating with Statkraft for 2 MW pilot plants	www.nitto.com
Oasys Water	US	Desalination company	Spin-off from Yale University. Holds several patents in the area of desalination and Salinity gradient. Also active in the fracking market	www.oasyswater.com
OsmoBlue	CH	Start-Up	Focusing on waste heat recovery. Conversion of low-temperature waste heat recovery by using PRO.	www.osmoblue.com
Pentair X Flow	NL	Membrane producer	Water Process Technology. Active in water purification, wastewater treatment, seawater pre-treatment, food and beverage industry	www.x-flow.com
Porifera	US	Start-Up	Membrane developer in the area of forward osmosis	www.porifera.com
Red Stack	NL	Start-Up	Developing RED. Builds the 50 kW pilot plant at Afsluitdijk, The Netherlands.	www.redstack.nl
Statkraft	NO	Electricity company	Big electricity company, mainly using hydropower. Built the 10 kW PRO pilot plant in Tofte. No longer active in the field.	www.statkraft.com
Toray Industries	JP	Membrane producer	Corporation active in polymer chemistry and biochemistry. Water treatment section active in water treatment membranes and modules.	www.toray.com
Wetsus	NL	Research and Consultancy	Focussing on capacitive power production, RED membrane development and fouling management.	www.wetsus.nl

5 ACTIONS AND CHALLENGES

The increased interest in developing ocean energy technologies witnessed at policy level over the past few years has led to the identification of the barriers that are currently hindering the commercialisation of ocean energy technologies: technology development, finance, consenting and environmental issues, and the availability of grid infrastructure (MacGillivray *et al.* 2013; IRENA 2014b). Strategic actions and policy implementation have been presented by the SI Ocean project specifically for wave and tidal technologies (Badcock-Broe *et al.* 2014; Magagna *et al.* 2014), and by IRENA (IRENA 2014b) in a broader context. All reports highlighted how the main challenges that ocean energy is facing are interdependent of one another and require concerted and collaborative efforts among developers, academia and policy makers.

The 'Blue Energy Communication' presented by the European Commission in January 2014 highlighted the current gaps and proposed an action plan to aid the development and uptake of ocean energy (COM(2014) 8 final 2014), setting a framework for implementation.

The process was initiated by the creation of the Ocean Energy Forum, a platform to bring together ocean energy actors and stakeholders to discuss common issues and identify viable solutions for the sector. The main output expected from the Ocean Energy Forum is a strategic roadmap defining targets for the industrial development of the sector and a clear timeframe for its implementation.

The Ocean Energy Forum has been asked to focus on three primary areas to overcome specific gaps:

- **Technology and resources:** looking at ensuring the development of reliable, viable, efficient and survivable ocean energy technologies. An important part of the work is dedicated to detailed resource mapping, both in terms of physical resources and the availability of ports, vessels and other ancillary services.
- **Finance:** aiming at identifying methods for the optimal financing of RD&D for ocean energy technologies and how to trigger inward investment in the sector.
- **Environmental and administrative issues:** the novelty of the sector and of its technologies raises a series of concerns with regards to the potential impacts of ocean energy on the environment, requiring extensive monitoring from developers. Further uncertainties arise in relation to the existing EU policy frameworks, which regulate the deployment of energy systems, and the need of

developing guidelines and best practices to evaluate ocean energy technologies. Focus will also be given to solving current administrative issues and reducing the lead times for consenting and licensing of sites.

The second phase (2017–2020) of the action plan foresees the creation of a European Industrial Initiative (EII) for Ocean Energy, as already put in place by other renewable sectors (e.g. wind), within the SET Plan framework (COM(2014) 8 final 2014). Such a solution could help foster technology innovation, enhance risk sharing among stakeholders, formalise cooperation activities and implement the Ocean Energy Roadmap put forward by the Ocean Energy Forum.

5.1 Identifying Priorities and Actions

In addition to the Blue Energy Communication, the European Commission has recently released the document 'Towards an Integrated Roadmap and an Action Plan' (EC 2014a), the initial outputs of the European Commission's Communication on Energy Technologies and Innovation (COM(2013) 253 2013). The aim of the Integrated Roadmap is to consolidate the updated technology roadmaps of the SET Plan and propose research and innovation actions designed to facilitate integration of energy technologies across the EU level.

The document, based on inputs received by stakeholder groups (EC 2014b), presents key research, development and market priorities for energy technologies. Ocean energy priorities were defined as follows:

- **Advanced research (TRL 1–3):** Develop methodologies for site characterisation; develop devices, components and materials, grid services and inter-array interaction, and array design and modelling tools.
- **Industrial research and demonstration (TRL 4–6):** Test and demonstrate ocean energy components, technologies, systems and arrays; demonstrate marine technology access and logistics.
- **Innovation and market uptake (TRL 7–9):** Deploy early commercial arrays and grid integration, including standards; develop manufacturing and mass-production techniques, taking into account the whole supply chain; develop a framework for consenting procedures, and environmental and socio-economic assessment; assess impacts on marine ecosystems and methodologies for power take-off systems; support training and education.

Research and innovation actions, presented in the Annex document (EC 2014b), describe in detail suggested ways of implementing and addressing the sector's key priorities. These inputs will form the basis for the development and implementation of an action plan, together with the Member States, to deliver a secure, efficient and sustainable EU energy system.

The current EU policy context, in addition to R&D funds provided over the years, appears ready to support the growth of the ocean energy sector; thus providing the necessary momentum to facilitate market establishment and attract investment in the sector.

The following subsections address activities and initiatives that are being put in place in order to overcome existing barriers, focussing on the specific areas identified by the Blue Energy Communication. In addition, a section addressing the issues related to grid availability and integration of ocean energy is presented.

5.2 Technology and Resources

Despite recent progress, no ocean energy technology developed thus far has achieved the level of technological readiness required to be competitive with other RESs or sufficient to ensure commercialisation of the technology (Figure 35).

Technological barriers represent the most important issue that the ocean energy sector needs to address

in the short–medium term. A survey carried out by the SI Ocean consortium revealed that technology issues account for 37 % of the key priorities for the wave and tidal energy industries (MacGillivray *et al.* 2013), whilst Tidal Today indicated that technology development (32 %) is one of the key issues for the tidal sector in the next 12–18 months (Tidal Today 2014b).

The announcements of Siemens divesting from tidal energy, Pelamis filing for administration and Aquamarine Power rescaling their activities have affected and shocked the sector, and highlight how technology development is paramount for the growth of the sector and for the establishment of an ocean energy market in Europe and globally. Developing reliable technology is therefore fundamental to ensuring the establishment and growth of the ocean energy market. Overcoming technology issues, first and foremost, will likely have an effect on the other barriers hindering the sector (IRENA 2014b).

Thus, mechanisms should be identified to facilitate the progression of ocean energy technologies to higher TRLs, towards commercialisation, whilst technology innovation should be fostered to unlock cost-reduction mechanisms for ocean energy technologies.

The SI Ocean Strategic Technology Agenda has proposed a number of mechanisms to facilitate technology development and progression to overcome technical challenges (Magagna *et al.* 2014). Despite being focussed exclusively on wave and tidal

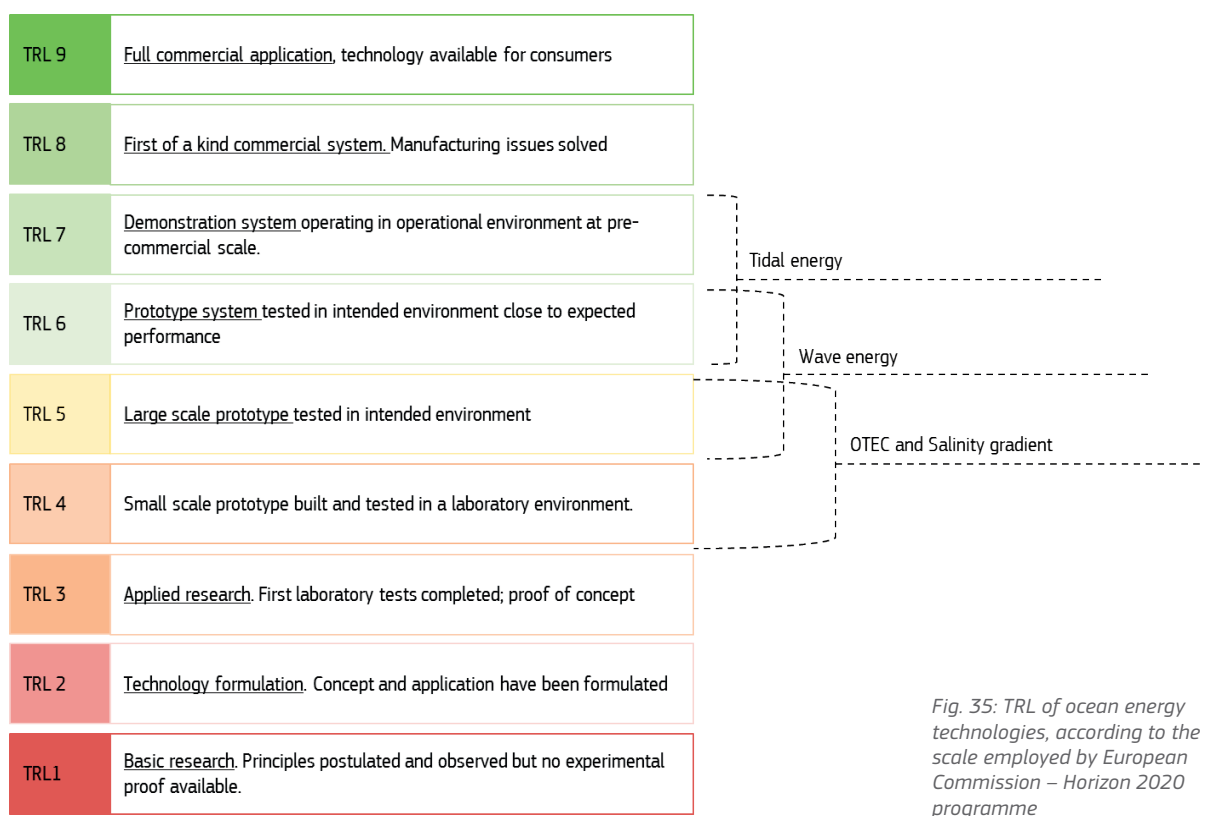

Fig. 35: TRL of ocean energy technologies, according to the scale employed by European Commission – Horizon 2020 programme

technology, the document identified a two-stream approach, focussing on ‘technology development’ and ‘deployment and risk reduction’ to drive the sector towards commercialisation (Figure 36).

At a high level, the proposed actions could be adapted to ocean energy technologies as a whole. A concerted effort should be made to put in place policy mechanisms to facilitate the development of reliable, survivable and cost-effective ocean energy technology, in accordance with EC 2014a. In the first instance, actions are aimed at increasing performance improvement of single and array devices, whilst the latter focus should be given to increasing the deployment rate of technologies and facilitating learning-by-doing.

The EU framework programme for research and innovation, Horizon 2020, could play a significant role in the implementation of actions aimed at solving technology issues. The programme has identified areas for research, innovation, development and demonstration for low-carbon energies, with dedicated funding programmes based on current TRLs.

With regards to ocean energy technologies, the implementation mechanism should focus on:

- Demonstration of advance technologies: validation of technology at full scale through extensive testing and aiding of pilot and first-of-a-kind commercial array deployment
- Progressing early stage technology to higher TRLs, and through the development of innovative technologies, new materials and enhanced components.

Such a distinction allows matching the ideal funding structure with specific technology needs, as seen

in other sectors. Fundamental parameters for assessing the success and progress of the technologies will be the definition and achievement of performance targets and key performance indicators (KPIs) for each ocean energy technology type. Both the wind energy and the photovoltaic EII have defined different targets, expected LCOE and KPIs for each different technology type. Developing and implementing technology-specific funds and KPIs ensure that technology development can happen without placing excessive expectations or unrealistic targets on a particular technology, thus reducing risk for both developers and investors. The process started by the European Commission with the Integrated Energy Roadmap (EC 2014a) has already seen KPIs defined for the whole sector.

The development of standards, such as the one being developed by the International Electrotechnical Commission (IEC), which clearly define required levels of survivability and reliability for each TRL, would provide a clearer indication of the development of the technologies, as they improve towards commercialisation.

Nevertheless, in order to facilitate the progression of ocean energy technology to higher TRLs, it is also necessary to ensure that increased innovation and research efforts can take place, that best practice sharing is encouraged to spread the risk among stakeholders and that the development of test centres is supported. Activities and actions are currently being undertaken at global, regional and national levels. Key activities are summarised in Table 23.

In Europe, in addition to the schemes presented in Table 23, a number of projects have been funded through the FP7 framework or national schemes,

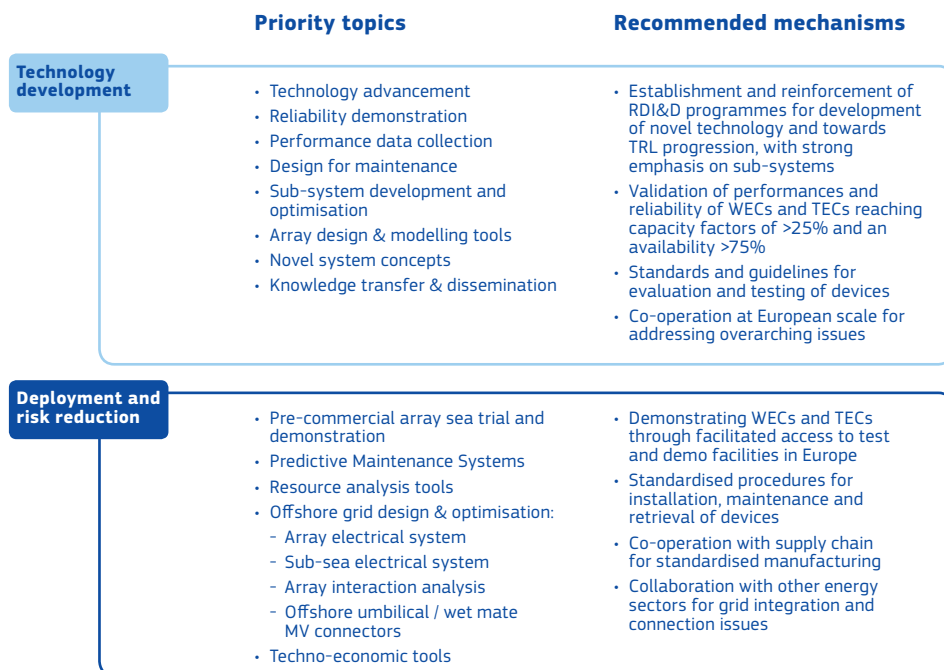

Fig. 36: Key recommendations from the SI Ocean Wave and Tidal Strategic Technology Agenda

such as Supergen, to address specific technology topics. However, a general consensus has been reached on the type of technology challenges and topics that need to be addressed (Table 24).

Technology development is essential to ensure that ocean energy technologies become cost competitive with both alternative and conventional energy

sources in the long term. Currently, the LCOE of ocean energy technologies indicates that they are lagging behind established technologies (Figure 37).

Over the past two years increased efforts have been witnessed at the global and European levels to help the ocean energy sector overcome the technology-specific issues that are hindering its

Table 23: Concerted activities and actions to overcome ocean energy technical challenges

Entity	Action	Type	Description
Ocean Energy System	Annex II	Global	This annex aims to develop recommended practices for testing and evaluation of ocean energy systems, to enhance the comparability of experimental results. The work is separated into three main tasks, addressing site data, device development and guidelines for open-sea testing of devices.
	Annex V	Global	Annex V looks at facilitating the exchange and assessment of project information and experience from test centres. This work plays an important part in information sharing, to accelerate the technical understanding of ocean energy conversion technologies.
Ocean Energy Forum Ocean Energy Europe	TP Ocean	European	The Technology and Innovation Platform for Ocean Energy is coordinating the technology stream of the Ocean Energy Forum. The stream has been divided in four main technological working groups, addressing: measurement and data, logistics and operations, prime movers, and components/subcomponents. Each working group is working to prioritise a series of topics that require R&D actions.
IRENA	Policy	Global	IRENA comprises 135 states, and has recently produced a series of policy and innovation recommendations for ocean energy development.
OceaneraNET	RD&D	European	OceaneraNET is an FP7 project comprising the research councils of different EU Member States. The project launched its first call for applications specific to technology development of ocean energy converters in October 2014.
MaRINET	RD&D	European	MaRINET is an FP7 project comprising 42 partners, providing access to experimental facilities across Europe at different scales for testing, research and optimisation of wind, wave and tidal energy technologies.

Sources: OceaneraNET 2014; IEA-OES 2014a; IEA-OES 2014b

Table 24: Ocean energy technology challenges and research focus areas

Area	Topics
Resource measurement and assessment	<ul style="list-style-type: none"> - Resource assessment methodologies, measurement systems, understanding of details, adequate forecasting - Design for extreme conditions (including maintenance, control and operation, installation) - Resource quantification and characterisation for long-term climate impact - Forecasting of incoming wave power
Technology design, performance and integrity	<ul style="list-style-type: none"> - Reliability and performances of devices for 20-year lifetime expectancy (devices and subcomponents) - Robustness of devices: design for extreme conditions, robustness and efficiency - Field testing of prototypes and demonstration units (TRL based) - Reduction of O&M costs - Modelling of devices and arrays - Materials: effects of ageing, fouling and corrosion, and development of novel materials
Components and sub-components for balance of plant and system	<ul style="list-style-type: none"> - Grid and cabling integration - Array cabling positioning and cable protection - Collaboration with wind on grid issues - Fatigue dynamics of systems and sub-systems (e.g. umbilical and power connectors) - Moorings and foundations: common structures, designs and survivability - PTO optimisation
Logistics, installation and operations	<ul style="list-style-type: none"> - Operations and maintenance: best procedures, installation methods, maintenance access and scheduling, and vessels - Atomisation of inspection techniques - Monitoring health of assets - Health and Safety requirements - Vessels and offshore supply chain - Optimisation of operation, weather windows and capacity factors

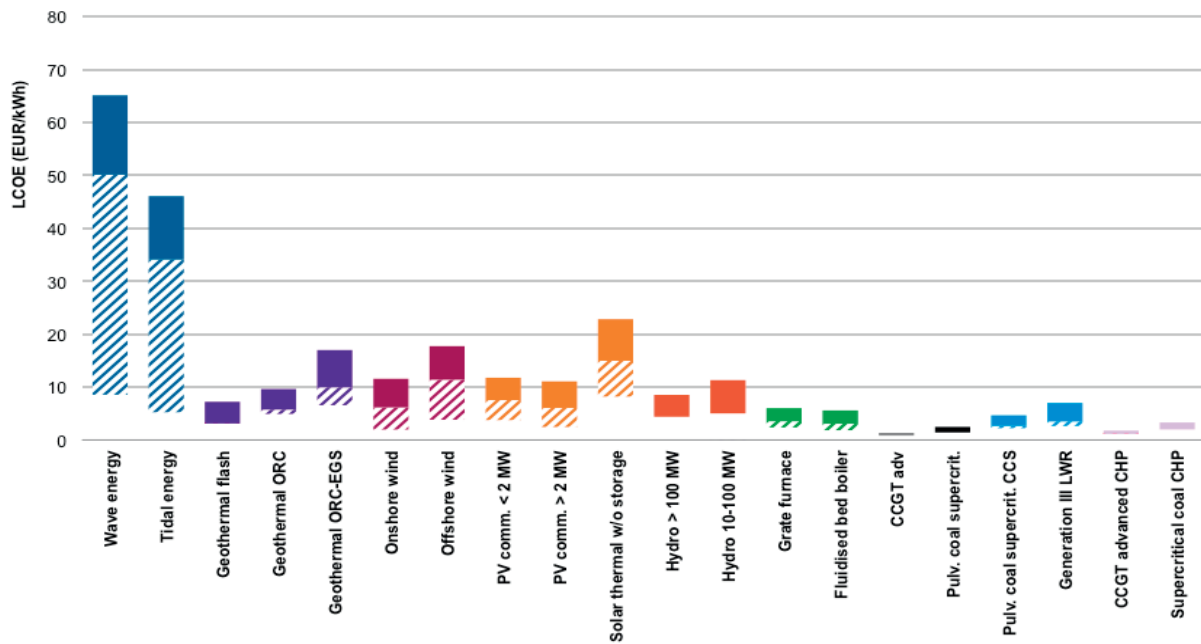

Figure 37: LCOE for alternative and conventional energy technologies. Calculation based on ETRI 2014

development. Whilst the level of success of given mechanisms may be dependent on the implementation of policy and funding/financing instruments put in place, the sector now has a clearer view of what may be required, from a technology standpoint, to ensure growth and development of the market.

5.3 Finance

In the past, developments in ocean energy were funded by private companies and public sources. Whilst initially, governmental support was the main source of funding, private finance has slowly increased (Badcock-Broe *et al.* 2014). In 2011, 50 % of RD&D investment in the EU was coming from private sources, 32 % from Member States and 18 % from European funds (Figure 38).

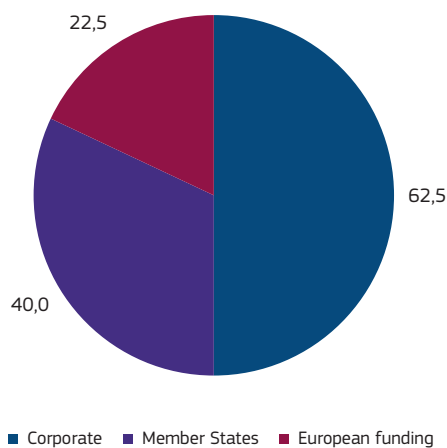

Fig. 38: Total RD&D investment in wave and tidal energy projects in 2011 in m EUR. Source: Corsatea & Magagna 2013

Market leaders in Europe are currently reaching financial close for the deployment of pre-commercial and first-of-a-kind arrays (Section 2.3.1). Still, securing investment for pilot arrays is one of the greatest challenges the ocean energy sector currently faces, mainly due to high CAPEX for the first arrays (IEA-OES 2013; Badcock-Broe *et al.* 2014).

Besides continued private investments, public financial support for ocean energy technologies will be needed. Such support could consist of both market push and pull mechanisms (Badcock-Broe *et al.* 2014). An overview of current public support mechanisms in EU Member States is given in Table 25, whilst Table 26 and Table 27 show support mechanisms from the EU and from non-EU countries, respectively.

Support mechanisms for emerging technologies need to be implemented with adequate timing in view of the market maturity of the technology concerned (Magagna *et al.* 2014). Whilst more technology-oriented mechanisms are needed during the first stages of technology development, market push and pull instruments have to come into play at a later stage. Taking into account the current technological status of ocean energy, only leading tidal energy technologies have shown to be at the stage where market push mechanisms can help the uptake of the technology (Figure 39).

When comparing the current state of technology development and maturity, it seems that public support mechanisms are adequate, provide specific mechanisms to accommodate the current differences in technology advancement in wave and emerging ocean energy technologies, and facilitate the creation of the tidal energy market.

Table 25: Current market push and pull mechanisms for ocean energy from EU Member States

Country	Type	Description
United Kingdom	Pull	Renewable Obligation (RO) Scheme. Renewable Obligation Certificates (ROCs) buyout price set to 30 GBP in 2002/3 rising to 43 GBP in 2014/15. RO scheme will be replaced by a Contract for Difference (CfD) scheme in 2017.
	Push	Renewable Energy Investment Fund (REIF) Scotland, 103 m GBP.
		Marine Energy Array Demonstrator (MEAD), 20 m GBP. MEAD aimed at supporting two pre-commercial projects to demonstrate the operation of wave and/or tidal devices in array formation for an extended period of time, MeyGen project (Table 8).
		Energy Technologies Institute (ETI), about 12 m GBP for wave and tidal projects.
		The Crown Estate, 3 m GBP spent for enabling activities in the area of project development processes, committed to invest and manage an additional 5.7 m GBP in enabling actions for Pentland and Orkneys. Plans to invest up to 20 m GBP in first array projects.
		Marine Renewables Commercialisation Fund (MRCF) Scotland, 18 m GBP. Aquamarine Power and Pelamis Wave Power have been awarded 13 m GBP. 5 m GBP for enabling technologies.
Marine Renewables Proving Fund (MRPF), 22.5 m GBP. Managed by Carbon Trust. Funds awarded to six projects.		
		Saltire Prize, Scotland, 10 m GBP. For first device delivering > 100 GWh for two years.
France	Pull	Feed-in Tariff for renewable electricity. Currently 15 c EUR/kWh for ocean energy.
	Push	ADEME, 1125 m EUR (renewable energy and green chemistry). Specific call for ocean energy funds projects with 4–6 machines at min. generation of 2500 MWh per machine for 2 years. Eight projects have submitted proposals, selection finalised by end of 2014. Each project might receive 30 m EUR and benefits from a Feed-in Tariff of 17.3 c EUR/kWh.
Ireland	Pull	Feed-in Tariff for ocean energy of 0.26 c EUR/kWh (up to 30 MW) from 2016.
	Push	SEAI Prototype Development Fund, 26 m EUR.
		Ocean Energy Development Budget will be increased by 16.8 m EUR to 26.3 m EUR by 2016, mainly for test centres.
		SEAI Sustainable RD&D programme, 3.5 m EUR.
Portugal	Push	Fundo de Apoio à Inovação (FAI) for renewable energies, 76 m EUR total.
Spain	Pull	Feed-in Tariff suspended for all renewables, replaced in 2014 by a scheme of a fixed annual investment bonus for existing installations.
	Push	EVE, 3 m EUR scientific programme for ocean energy demonstration.
Denmark	Pull	Maximum tariff of 8 c EUR/kWh (sum of market price and bonus) for ocean energy.
	Push	Energinet.dk, 2.4 m EUR for minor renewable energy technologies (e.g. PV, wave, biogasification) by ForskVE. In 2015 round, the programme for development and demonstration projects will provide about 13.4 m EUR of funds.
Germany	Pull	Feed-in Tariff, 3.5–12.5 c EUR/kWh for ocean energy, depending on installed capacity.

Sources: IEA-OES 2012; IEA-OES 2013; ADEME 2013; SEIA 2013; The Crown Estate 2013; Badcock-Broe et al. 2014; EVE 2014; Sabella 2014; The Crown Estate 2014; Knowledge Transfer Network 2014; Real Decreto 413/2014 2014; Orden IET/1045/2014 2014; Energinet.dk 2014; EEG 2014

Table 26: Current market push and pull mechanisms for ocean energy from the EU

Fund	Type	Description
NER 300	Push	Demonstration programme for renewable energy and CCS projects, 2.1 bn EUR. Funds five ocean energy projects (two wave, two tidal, one OTEC) in the EU (about 140 m EUR).
H 2020	Push	EU Research and Innovation programme, 80 bn EUR from 2014 to 2020. Ocean energy is one of the priorities of the programme. Until now, four calls in the area of low-carbon energy (approx. 85–110 m EUR each) have been launched, funding the development of innovative designs and components, and research to ensure efficiency and long-term reliability, but also the demonstration of advanced full-scale devices in real-world conditions. About 200 m EUR have been earmarked for marine research and innovation in 2014 and 2015.
Structural and cohesion funds	Push	The two structural funds, the European Regional Development Fund (ERDF) and the European Social Fund (ESF), provide support for the creation of infrastructure and productive job-creating investment, and for the integration into working life of the unemployed and disadvantaged sections of the population. The cohesion funds (total 63.4 bn EUR) also support projects related to the use of renewable energy.

Sources: Commission Decision C(2012) 9432 2012; Commission Decision C(2014) 4493 2014; Commission Decision C(2014) 383 2014; Marine Institute 2014; EC 2014c; EC 2014d; EC 2014e

Table 27: Current market push and pull mechanisms for ocean energy from non-EU countries

Country	Type	Description
China	Push	Special funding programme for MRE (SFPMRE) of about 40 m USD. Twelve R&D and demonstration projects (wave and tidal) are being funded.
	Pull	Renewable energy electricity price tariff (about 1.5 c EUR/kWh).
US	Push	Water Power Program (WPP) of Department of Energy (DOE) focussing on wave energy mainly. Portfolio in 2013: 87 projects, 33.8 m USD Small Business Innovation Research (SBIR)/Small Business Technology Transfer (STTR) program of DEO, awards up to 150 k USD per company working on technology development.
	Pull	Renewable Portfolio Standard (RPS) requires utility companies to supply a certain amount of electricity produced by renewable energy.
Korea	Push	Ministry of Oceans and Fisheries (MOF) and Ministry of Trade, Industry and Energy (MOTIE) operate RD&D programmes for ocean energy (fundamental R&D and demonstration projects).
	Pull	Feed-in Tariff of about 7–8 c EUR/kWh (total compensation).
Norway	Push	Norwegian Energy Agency (Enova), Innovation Norway, Research Council of Norway, total funds approximately 110 m EUR.
	Pull	Feed-in Tariff for tidal energy for projects at development or testing stage, initial tariff of 37.5 c USD/kWh to 57.5 c USD/kWh declines with increasing output. Feed-in Tariff in Nova Scotia for small-scale in-stream devices from local communities (COMFIT), 65.2 c USD/kWh.
Canada	Push	Clean Energy Fund (CEF), Program for Energy Research and Development (PERD), ecoENERGY Innovation Initiative (ecoEII), total funds of 37 m USD since 2010. Sustainable Development Technology Canada (SDTC), 13 m USD for development and demonstration of ocean energy technologies.
	Pull	Australian Renewable Energy Agency (ARENA) with funds of about 2.5 bn AUD until 2022, also responsible for ocean energy where capacity building, knowledge generation and pilot-scale projects will be funded.

Sources: Wang et al. 2011; IEA-OES 2013

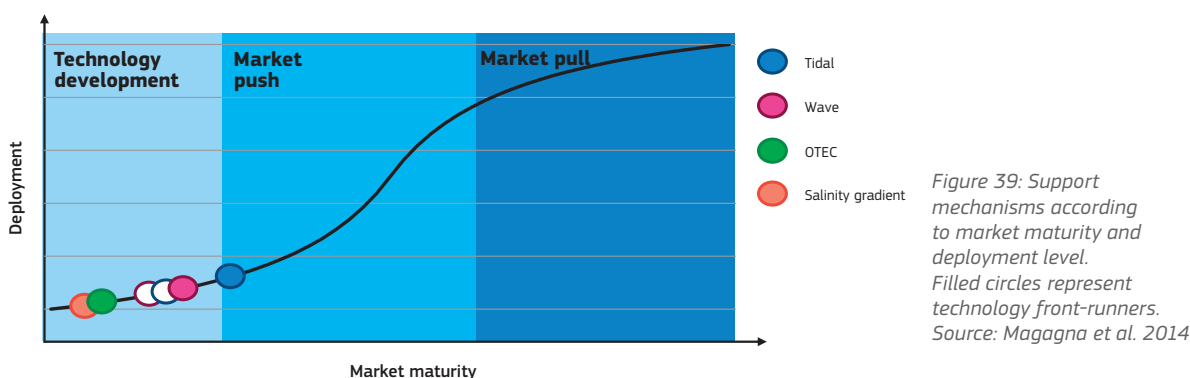

5.4 Environmental and Administrative Issues

The interaction of ocean energy converters with the surrounding marine environment is one of the barriers that the ocean sector is currently facing. Worldwide policy measures are in place in order to ensure that the potential impacts of any anthropic actions on the marine environment are mitigated and minimised.

Given the nascent status of ocean energy, deployments are often associated with unknown envi-

ronmental impacts, leading to increased scrutiny by regulating and licensing authorities and stakeholders of the potential effects that they could have on the marine habitat.

The uncertainties in identifying and mitigating environmental and socio-economic impacts, coupled with current licensing measures not implemented to assess ocean energy technologies, constitute one of the major barriers to ocean energy development. Recognised bottlenecks with regards to environmental and administrative issues that the ocean energy industry faces include:

- **Environmental:** Stringent and costly monitoring requirements, in particular in relation to the size of the project. An additional burden faced by developers in Europe and US relates to monitoring required prior and after consent. A conservative approach is often taken by regulatory authorities, which, unsure of the environmental impacts of ocean energy technologies, enforce extensive monitoring requirements on developments.
- **Administrative:** Lengthy procedures to obtain full consent. There are a lack of uniform procedures with regards to licensing and consenting, both globally and at the EU level; often different consents are required, increasing the time and burden on project developers.
- **Social acceptance:** Ocean energy deployments can experience significant delays and opposition from local communities if they are not correctly engaged.

Whilst it is likely that the above issues will fade with improvements to the technologies, with increased knowledge, and with more familiarity of the regulating authorities with project developments, addressing the above issues in the short term will remove the inherent sense of risk perceived by developers and allow the design of mitigation measures to minimise or eliminate significant environmental impacts.

In the past few years a number of initiatives have been undertaken to address administrative bottlenecks, environmental uncertainties and social impacts of ocean energy converters. IEA Ocean Energy Systems has implemented Annex IV to increase the understanding of the environmental effects of ocean wave, tidal, OTEC and salinity gradient technologies on the marine environment

(IEA-OES 2014c). Also, ongoing standardisation activities on ocean energy, under IEC Technical Committee 114, include the evaluation and mitigation of environmental impacts (IEC 2015).

At the European level, different projects such as ORECCA, WavePlam, SOWFIA and SI Ocean aim at addressing administrative and environmental barriers. They focus on identifying scope for streamlining consenting processes across Europe, and for the development of environmental best practices and joint monitoring programmes. A fundamental step undertaken in the process of drawing up recommendations consisted in an extensive review of:

- The implementation of environmental legislation and energy policy across the different Member States, including the EIA Directive, the SEA Directive, the Birds and Habitat Directive, the Energy Directive and the Marine Strategy Framework Directive (MSFD).
- Monitoring methodologies, environmental standards and state-of-the-art environmental impact assessments for wave and tidal energy projects.
- The policy scenarios across Europe, and the implementation of consenting procedures in each Member State of the European Union.

It is important to note that the sets of recommendations provided by the various projects are convergent and have found wide support among European stakeholders, including developers, academics and scientists, as presented in the Annex document of the Integrated Roadmap (EC 2014b). Specific recommendations include:

- Ensuring that existing consenting procedures for ocean energy are fit for purpose, possibly by

Table 28: Review of consenting processes across EU Member States located in the Atlantic Arc

Country	Strategic Environmental Assessment for Ocean Energy		Maritime Spatial Plan in Place	'One-Stop-Shop' for Consenting
	Wave	Tidal		
Denmark	No	No resource	Under development	Yes
France	No	No	Under development	No
Ireland	Yes	Near completion	No	No
Portugal	Partially	No resource	Yes	Under development ^a
Spain	No	No resource	Yes ^b	No
UK – Scotland	Yes	Yes	Near completion ^c	Yes
UK – England	Yes	Yes	Under development	Yes
UK – Wales	Yes	Yes	Under development	No
UK – Northern Ireland	Yes	Yes	Under development	Under development

^a dedicated consent not yet completely streamlined, encompassing 4 different authorities;

^b adopted under the MSFD;

^c Draft National Marine Plan for Scotland not yet published

Sources: ORECCA 2011; Holcombe-Henley 2013; SOWFIA 2013a; SOWFIA 2013b; Badcock-Broe et al. 2014

implementing a ‘one-stop-shop’ for consenting across the EU or ensuring interdependency of permits.

- Designing monitoring requirements that are fit for the project size, with regards to data collection, to ensure developers’ costs are minimised.
- Accelerating learning rate with regards to potential impacts due to ocean energy developments, by facilitating adaptive management (survey–deploy–monitor), importing the experience of test centres and developing an EU-wide research programme on environmental impacts.

5.5 Grid Availability and Integration: A Joint Approach

The availability of grid near in the proximity of proposed ocean energy projects is one of the rising issues for the ocean energy sector, which is looking to move towards the deployment of early arrays. Areas in Europe that offer good ocean energy resources are remote and often not connected with existing grid installation, thus requiring either grid upgrades or new-built capacity. Grid availability, however, is not expected to be critical in all markets, providing an advantage to countries where resources are located more closely to distribution centres, such as France, Portugal and The Netherlands (IRENA 2014b).

Depending on the location, device/project developers may have to cover part of the costs associated with any updates (O’Sullivan & Dalton 2009), according to the charging regime in place in a determined area. Two common charging systems are in place in Europe: deep charging, where the developer pays for the equipment and the reinforcement of the grid infrastructure, and shallow charging, where developers cover the cost of equipment (e.g. cables, substations) and the grid or transmission operator covers the cost of grid reinforcement.

Despite the introduction of the RES Directive and EU policies pushing for the implementation of shallow-charging regimes, in many instance deep-charging regimes are found to be prevalent in the EU (Scott 2007). To a certain extent, the ocean energy sector is in a similar position to where the wind industry was previously, in developing a resource-based technology with most of the current infrastructure developed on availability and usage. Grid-availability issues are starting to be experienced now with the announcement and the development of the first array projects, with technologies moving away from ad-hoc test centres. The European Wind Energy Association (EWEA) has already proposed guiding principles for the integration of wind energy within the existing grid infrastructure, focussing on the framework set by the

RES Directive to guarantee transmission and distribution of the electricity generated by renewable sources (EWEA 2012).

The development of a more integrated European grid, presented by the European Network of Transmission System Operators for Electricity (ENTSO-E), and the implementation of the 2030 Climate and Energy Policy Framework will play an important role in defining renewables integration in the European energy system (ENTSO-E 2014a; European Council 2014). In this context, ENTSO-E has already stated that meeting the new targets will require the development of new infrastructure (ENTSO-E 2014a). There is therefore scope for RES stakeholders and energy developers to ensure that renewable electricity in remote locations is taken into account, and upgrades timely implemented.

Additionally to grid-availability issues, there are a number of technical issues that technology developers need to solve concerning the integration of ocean energy power within the existing grid infrastructure, in order to ensure grid stability and power smoothing, and matching the requirements of traditional transmission and distribution systems. As seen in previous sections, frequency converters are often employed along PTO to optimise electricity generation and match the renewable source to grid requirement (O’Sullivan & Dalton 2009). In Europe, Transmission System Operators (TSOs) have defined grid and distribution codes, which regulate the connection of electricity generators to the distribution network (Preda *et al.* 2012; ENTSO-E 2014b).

A review of grid integration and power quality has been developed within the MaRINET project, highlighting that employing state-of-the-art technology from wind, such as frequency converters, will likely allow for grid-compliant installations of ocean energy farms (Giebhardt *et al.* 2014). Similarly, with regards to power quality of wave and tidal energy, the reports highlights the strong connection of the IEC62600 Standard ‘Marine Energy – Wave, tidal and other water current converters’ with its wind correspondent, IEC61400-21 ‘Wind turbine generator systems’.

The correspondence and rooting of ocean energy grid codes and power quality of ocean energy systems within wind energy industry technology offer areas for concerted RD&D efforts between the two sectors. Electrical and infrastructural costs account for about 10–15 % of wind and ocean energy farms’ expenditure, and the identification of mutual solutions to both availability and integration issues will provide a common avenue for the reduction of LCOE, and a pathway for R&D synergies in both sectors (Figure 40).

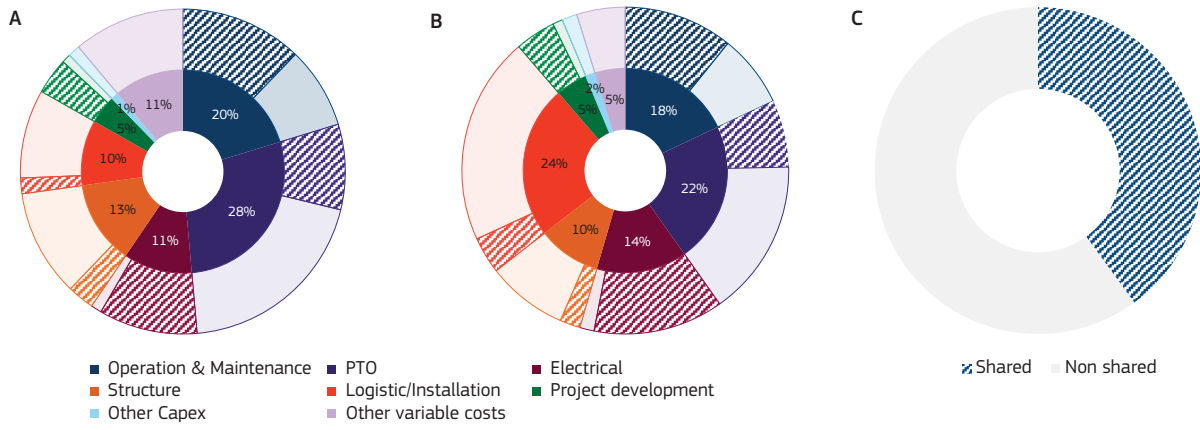

Fig. 40: Synergies between wave and tidal and offshore wind cost components. A: Wind, B: Wave and Tidal, C: Overall. Source: JRC 2014

6 KEY FINDINGS AND CONCLUSIONS

This report aimed at presenting the overall state of play of ocean energy in Europe and globally in 2014. The report analysed in depth the four main types of ocean energy conversion technologies and the key activities undertaken to ensure and facilitate their commercialisation. Emphasis was given to wave and tidal energy technologies, which at the moment represent the most advanced types and those expected to contribute in the near future to the European integrated energy system. OTEC and salinity gradient technologies are currently behind in terms of development, with the first models ready for trial deployments.

The year 2014 represented a significant milestone for the sector from a policy standpoint, with the publication of the Blue Energy Communication, the establishment of the Ocean Energy Forum and the European Technology and Innovation Platform for Ocean Energy (TIP). The announcement of the awards for the second NER 300 call has seen the number of ocean energy arrays expected to be deployed in European waters by 2018 or earlier rising to five. On the other hand, forecasts of expected ocean energy capacity by 2020 have been further reduced, due to the slow technological progress of the sector and difficulties in attracting funds and financing. The slow growth of the sector and delays in the formation of the market have forced key developers and OEMs to either downsize or withdraw their interest in developing ocean energy technology.

The ocean energy market is still in its infancy, and whilst foundations for its growth have been put in place, the sector seeks to further prove the reliability of its technology moving towards demonstration of pre-commercial arrays. A number of key developments have been seen in 2014 to ensure the establishment of ocean energy markets in Europe and worldwide, including:

- About 30 tidal and 45 wave energy companies are currently at an advanced stage of technological development, with a number of technologies nearing pre-commercial array demonstration and others deploying full-scale prototypes in real-sea environments.
- Europe could see up to 40 MW of tidal installed capacity by 2018, and 26 MW of wave energy

capacity, if proposed and awarded projects go ahead and reach financial close.

- The deployment of the first tidal energy array is expected for 2016 in the UK, with MeyGen becoming the first ocean energy project to reach financial close. The tidal sector has seen an increased participation of OEMs in the development of technology and in promoting tidal farms across Europe; however, the costs and reliability of technologies will be paramount in assuring further developments. The development of second- and third-generation tidal technologies is opening up possibilities for cost reduction as well as deployments in low-energy-density water.
- The development of wave energy technologies is lagging behind that of tidal energy. However, deployment projects are currently taking place in Europe, the US and Australia. The sector is, however, seeing intensified collaboration to identify common PTO solutions.
- OTEC and salinity gradient technologies are developing demonstration plants. A 10 MW OTEC plant has been awarded funds through NER 300, whilst a 50 kW salinity gradient pilot-plant began operation in the Netherlands.

Ocean energy technologies face four main bottlenecks: technology development, finance and markets, environmental and administrative issues and grid. Overcoming these issues requires concerted efforts by industry, academia and the support of policy makers. Fundamental in overcoming technology barriers will be the implementation of technology-specific support mechanisms and KPI. Public mechanisms so far proposed appear to be adequate to sustain the growth of the sector, though it is essential they can be tailored to the needs of the various technologies and their status. Continued concerted efforts and the harmonisation of policy at MS levels are expected to help the sector overcoming administrative and environmental issues, whilst the shift towards a more integrated European Energy system may help alleviate the infrastructural issues such as grid availability.

A number of initiatives funded through the EU, IEA and research councils are looking to identify solutions to overcoming recognised barriers to commercialisation of ocean energy.

7 REFERENCES

- Achilli & Childress (2010). Achilli, A. & Childress, A. E.: Pressure-Retarded Osmosis: From the Vision of Sidney Loeb to the First Prototype Installation – Review. *Desalination* 261 (205–211). DOI: 10.1016/j.desal.2010.06.017.
- ADEME (2013). Programme démonstrateurs et plateformes technologiques en énergies renouvelables et décarbonées et chimie verte Appel à Manifestations d'Intérêt (AMI) Thématique Energies Marines. Fermes pilote hydroliennes.
- ADEME (2014). Investissements d'avenir: 2 projets sélectionnés dans le cadre de l'AMI fermes pilotes hydroliennes. URL: <http://www.presse.ademe.fr/wp-content/uploads/2014/12/20141203-CP-AMI-fermespiloteshydro.pdf>. Accessed: 9 December 2014.
- AEL (2014). Aviation Enterprises: New Third-Generation Spar Materials Set to Cut the Cost of Tidal Blades in 2014. Aviation Enterprises, Lambourn.
- Akram (2010). Akram, M. W.: Fatigue Modelling of Composite Ocean Current Turbine Blades. Masters Thesis, College of Engineering and Computer Science, Florida Atlantic University.
- Andritz (2014). Renewable Energy from Tidal Currents. Andritz Hydro Hammerfest, Hammerfest.
- Anonymous (1930). Power from the Sea. *Popular Mechanics Magazine* 54 (881–883).
- Aquamarine Power (2014). Aquamarine Power Releases Performance Data and Details of Planned Improvements to Oyster 800. URL: <http://www.aquamarinepower.com/news/aquamarine-power-releases-performance-data-and-details-of-planned-improvements-to-oyster-800.aspx>. Accessed: 28 January 2015.
- ARENA (2014a). Commercial Readiness Index for Renewable Energy Sectors. Australian Renewable Energy Agency (ARENA), Canberra.
- ARENA (2014b). Projects. URL: <http://arena.gov.au/projects/>. Accessed: 28 January 2015.
- Avery & Wu (1994). Avery, W. H. & Wu, C.: Renewable Energy from the Ocean. A Guide to OTEC. Oxford University Press, Oxford.
- Badcock-Broe *et al.* (2014). Badcock-Broe, A., Flynn, R., George, S. *et al.*: Wave and Tidal Energy Market Deployment Strategy for Europe. Strategic Initiative for Ocean Energy (SI Ocean).
- BBC (2014a). BBC News – Jobs Threat as Aquamarine Power 'Downsized'. URL: <http://www.bbc.co.uk/news/uk-scotland-scotland-business-30313111>. Accessed: 10 December 2014.
- BBC (2014b). BBC News – Hayle Wave Hub to Get First Energy Device. URL: <http://www.bbc.com/news/uk-england-cornwall-27929464>. Accessed: 28 January 2015.
- Berger & Berger (1986). Berger, L. R. & Berger, J. A.: Countermeasures to Microbiofouling in Simulated Ocean Thermal Energy Conversion Heat Exchangers with Surface and Deep Ocean Waters in Hawaii. *Applied and Environmental Microbiology* 51 (1186–1198).
- Big Island Video News (2012). OTEC Plans for NELHA Test Platform Detailed. URL: <http://www.bigislandvideonews.com/2012/07/26/otec-plans-for-nelha-test-platform-detailed-in-draft-ea/>.
- Bir & Migliore (2004). Bir, G. & Migliore, P.: Preliminary Structural Design of Composite Blades for Two- and Three-Blade Rotors. National Renewable Energy Laboratory (NREL), Golden, Colorado.
- Bir *et al.* (2011). Bir, G., Lawson, M. J. & Li, Y.: Structural Design of a Horizontal-Axis Tidal Current Turbine Composite Blade. ASME 30th International Conference on Ocean, Offshore and Arctic Engineering.
- Bluerise (2014). Offshore Ocean Thermal Energy Conversion. Feasibility Study of a 10MW Installation. Delft, The Netherlands.
- Bluewater (2014). Partners Sign Agreement to Install a Floating Tidal Energy Platform near Texel. URL: <http://www.bluewater.com/news-events/news>.
- BNEF (2014). Tidal Stream and Wave Power – A Lot Still to Prove. URL: <http://about.bnef.com/press-releases/tidal-stream-wave-power-lot-still-prove/>.
- Bosch Rexroth (2014). Wave Industry Leaders and Bosch Rexroth Join Forces to Develop a Standardised Offshore Power System. URL: <http://www.boschrexroth.com/en/gb/company/press/press-detail-2-77632>.
- Bower (2013). Bower, S.: Drivetrain Options for Tidal Stream. All-Energy Conference 2013.
- Brogioli (2009). Brogioli, D.: Extracting Renewable Energy from a Salinity Difference Using a Capacitor. *Physical Review Letters* 103 (058501). DOI: 10.1103/PhysRevLett.103.058501.
- Buonomenna (2013). Buonomenna, M. G.: Nano-Enhanced Reverse Osmosis Membranes. *Desalination* 314 (73–88). DOI: 10.1016/j.desal.2013.01.006.
- Business Green (2014). Siemens to Offload Marine Current Turbines' Tidal Power Business. URL: <http://www.businessgreen.com/bg/news/2383214/siemens-to-offload-marine-current-turbines-tidal-power-business>. Accessed: 27 November 2014.
- Capmix (2014). Objectives. URL: <http://www.capmix.eu/objectives>.
- Carbon Trust (2011). Accelerating Marine Energy: The Potential for Cost Reduction – Insights from the Carbon Trust Marine Energy Accelerator. Carbon Trust, London, UK.
- Carbon Trust (2014). Marine Renewables Commercialisation Fund – Carbon Trust. URL: <http://www.carbontrust.com/client-services/technology/innovation/marine-renewables-commercialisation-fund>.
- Cavrot (1993). Cavrot, D. E.: Economics of Ocean Thermal Energy Conversion (OTEC). *Renewable Energy* 3 (891–896). DOI: 10.1016/0960-1481(93)90047-K.
- Cebr (2014). Hogan, O., Sheehy, C., Ismail, O. *et al.*: The Economic Case for a Tidal Lagoon Industry in the UK. Centre for Economics and Business Research (Cebr).
- Charlier & Justus (1993). Charlier, R. H. & Justus, J. R. (eds): Ocean Energies: Environmental, Economic and Technological Aspects of Alternative Power Sources.
- Cheng *et al.* (2013). Cheng, Q., Zheng, Y., Yu, S. *et al.*: Surface Modification of a Commercial Thin-Film Composite Polyamide Reverse Osmosis Membrane through Graft Polymerization of N-isopropylacrylamide Followed by Acrylic Acid. *Journal of Membrane Science* 447 (236–245). DOI: 10.1016/j.memsci.2013.07.025.

- Chou *et al.* (2012). Chou, S., Wang, R., Shi, L. *et al.*: Thin-Film Composite Hollow-Fiber Membranes for Pressure-Retarded Osmosis (PRO) Process with High Power Density. *Journal of Membrane Science* 389 (25–33). DOI: 10.1016/j.memsci.2011.10.002.
- Claude (1930). Claude, G.: Power from the Tropical Seas. *Mechanical Engineering* 52 (1039–1044).
- Coastal Response Research Center (2010). Cunningham, J. J., Magdol, Z. E. & Kinner, N. E.: Technical Readiness of Ocean Thermal Energy Conversion (OTEC). University of New Hampshire, Durham.
- Cohen (2009). Cohen, R.: An Overview of Ocean Thermal Energy Technology, Potential Market Applications and Technical Challenges. 2009 Offshore Technology Conference.
- COM(2012) 494 final (2012). Blue Growth Opportunities for Marine and Maritime Sustainable Growth.
- COM(2013) 253 (2013). Energy Technologies and Innovation.
- COM(2014) 8 final (2014). Blue Energy: Action Needed to Deliver on the Potential of Ocean Energy in European Seas and Oceans by 2020 and Beyond.
- Commission Decision C(2012) 9432 (2012). Commission Implementing Decision of 18.12.2012. Award Decision under the first call for proposals of the NER 300 funding programme.
- Commission Decision C(2014) 383 (2014). Commission Implementing Decision of 31.1.2014 amending Commission Implementing Decision C(2012) 9432 so as to modify the Award Decision under the first call for proposals of the NER 300 funding programme.
- Commission Decision C(2014) 4493 (2014). Commission Implementing Decision of 8.7.2014. Award Decision under the second call for proposals of the NER 300 funding programme.
- Corsatea & Magagna (2013). Corsatea, T. D. & Magagna, D.: Overview of European Innovation Activities in Marine Energy Technology. Publications Office of the European Union, Luxembourg.
- Crown Estate, The (2013). The Crown Estate Wave and Tidal Programme. Investment in First Array Projects – Guidance Document, January 2013. The Crown Estate.
- Crown Estate, The (2014). Crown Estate Unlocks Further UK Wave and Tidal Current Opportunities. URL: <http://www.thecrownestate.co.uk/news-and-media/news/2014/further-uk-wave-and-tidal-opportunities-unlocked/>.
- Crown Estate, The (2014). The Crown Estate – Project Investments. URL: <http://www.thecrownestate.co.uk/energy-and-infrastructure/wave-and-tidal/wave-and-tidal-current/working-with-us/project-investments/>. Accessed: 8 October 2014.
- Cruz (2008). Cruz, J.: Ocean Wave Energy. Current Status and Future Perspectives. Springer.
- CSIRO (2012). Behrens, S., Griffin, D., Hayward, J. *et al.*: Ocean Renewable Energy: 2015–2050. An Analysis of Ocean Energy in Australia. Commonwealth Scientific and Industrial Research Organisation (CSIRO), Collingwood.
- Daily Fusion, The (2014). First Salinity Gradient Power Station to Open Next Month. URL: <http://dailyfusion.net/2014/01/first-salinity-gradient-power-station-to-open-next-month-26025/>.
- D'Arsonval (1881). D'Arsonval, J.-A.: Utilisation des forces naturelles. Avenir de l'électricité. *La Revue scientifique de la France et de l'étranger* 17 (370–372).
- Davies *et al.* (2013). Davies, P., Germain, G., Gaurier, B. *et al.*: Evaluation of the Durability of Composite Tidal Turbine Blades. *Proceedings of The Royal Society of London (A)* 371 (1–15).
- DCNS (2014a). DCNS Takes Control of OpenHydro. URL: <http://en.dcnsgroup.com/news/dcns-prend-le-control-dopenhydro>.
- DCNS (2014b). Ocean Thermal Energy Conversion. URL: <http://en.dcnsgroup.com/energy/marine-renewable-energy/ocean-thermal-energy>.
- DEME (2014). DP Marine Energy and DEMA Blue Energy Consortium Successful in Tender. URL: <http://www.deme-group.com/news/dp-marine-energy-and-deme-blue-energy-consortium-successful-tender>. Accessed: 16 September 2014.
- Devis-Morales *et al.* (2014). Devis-Morales, A., Montoya-Sánchez, R. A., Osorio, A. F. & Otero-Díaz, L. J.: Ocean Thermal Energy Resources in Colombia. *Renewable Energy* 66 (759–769). DOI: 10.1016/j.renene.2014.01.010.
- Drew *et al.* (2009). Drew, B., Plummer, A. R. & Sahinkaya, M. N.: A Review of Wave Energy Converter Technology. *Proceedings of the Institution of Mechanical Engineers, Part A: Journal of Power and Energy* 223 (887–902). DOI: 10.1243/09576509JPE782.
- EC (2014a). European Commission: Towards an Integrated Roadmap: Research and Innovation Challenges and Needs of the EU Energy System. Brussels.
- EC (2014b). European Commission: Strategic Energy Technology (SET) Plan. Towards an Integrated Roadmap: Research and Innovation Challenges and Needs of the EU Energy System. ANNEX I: Research and Innovation Actions.
- EC (2014c). EU Support for Ocean Energy. URL: http://ec.europa.eu/research/energy/eu/index_en.cfm?pg=research-ocean-support. Accessed: 10 October 2014.
- EC (2014d). Structural Funds and Cohesion Fund. URL: http://europa.eu/legislation_summaries/glossary/structural_cohesion_fund_en.htm. Accessed: 10 October 2014.
- EC (2014e). Cohesion Fund. URL: http://ec.europa.eu/regional_policy/thefunds/cohesion/index_en.cfm. Accessed: 10 October 2014.
- EEG (2014). Gesetz für den Ausbau erneuerbarer Energien – EEG 2014. BGBl. 2014 I Nr. 33 S.1066.
- Elghali *et al.* (2007). Elghali, S. E. Ben, Benbouzid, M. E. H. and Charpentier, J. F.: Marine Tidal Current Electric Power Generation Technology: State of the Art and Current Status. 2007 IEEE International Electric Machines and Drives Conference. IEEE.
- Emadzadeh *et al.* (2014). Emadzadeh, D., Lau, W. J., Matsuura, T. *et al.*: The Potential of Thin-Film Nanocomposite Membrane in Reducing Organic Fouling in Forward Osmosis Process. *Desalination* 348 (82–88). DOI: 10.1016/j.desal.2014.06.008.
- EMEC (2014a). Tidal Developers. URL: <http://www.emec.org.uk/marine-energy/tidal-developers/>. Accessed: 19 November 2014.
- EMEC (2014b). Wave Developers. URL: <http://www.emec.org.uk/marine-energy/wave-developers/>. Accessed: 19 November 2014.
- Energinet.dk (2014). ForskEL and ForskVE Call 2015. Energinet.dk.
- ENR (2014). Syndicat des Énergies Renouvelables: Annuaire de la filière française des énergies marines renouvelables. URL: <http://www.enr.fr/recherche-adherents.php>.
- ENTSO-E (2014a). Ten-Year Network Development Plan 2014. URL: <https://www.entsoe.eu/major-projects/ten-year-network-development-plan/tyndp-2014/Pages/default.aspx>.
- ENTSO-E (2014b). ENTSO-E Network Code for Requirements for Grid Connection Applicable to All

- Generators. URL: <https://www.entsoe.eu/major-projects/network-code-development/requirements-for-generators/Pages/default.aspx>.
- Ernst & Young (2013). *Rising Tide. Global Trends in the Emerging Ocean Energy Market*. Ernst & Young.
- ETRI (2014). Carlsson, J.: *Energy Technology Reference Indicator (ETRI) Projections for 2010–2050*. Publications Office of the European Union, Luxembourg.
- European Council (2014). European Council (23 and 24 October 2014). *Conclusions on 2030 Climate and Energy Policy Framework*. Brussels.
- EVE (2014). *Programa de ayudas a inversiones en energías renovables bases*. Ente Vasco de la Energía (EVE), Bilbao.
- EWEA (2012). Pineda, I.: *Good Practices for Grid Connection – European Wind Industry Perspective*. Sofia.
- Fava & Thomas (1978). Fava, J. A. & Thomas, D. L.: Use of Chlorine to Control OTEC Biofouling. *Ocean Engineering* 5 (269–288). DOI: 10.1016/0029-8018(78)90004-5.
- Finney (2008). Finney, K. A.: *Ocean Thermal Energy Conversion*. *Guelph Engineering Journal* 1 (17–23).
- Fortum (2014a). *Fortum och Seabased: Installationen av världens största vågkraftspark påbörjades idag utanför Sotenäs*. URL: <http://media.fortum.se/2014/07/01/fortum-och-seabased-installationen-av-varldens-storstavagkraftspark-paborjades-idag-utanfor-sotenas/>.
- Fortum (2014b). *Fortum to Continue Its Research Investments in Wave Power Technology Development by Acquiring a Stake in Wello Oy*. URL: <http://www.fortum.com/en/mediaroom/pages/fortum-to-continue-its-research-investments-in-wave-power-technology-development-by-acquiring-a-stake-in-wello-oy.aspx>.
- Fortum (2014c). *Fortum and Sitra Increased Their Contribution to Wave Energy Technology*. URL: http://www.google.nl/url?sa=t&rct=j&q=&esrc=s&source=web&cd=1&ved=0C-CMQFjAA&url=http%3A%2F%2Fwww.fortum.com%2Fen%2Fmediaroom%2Fpages%2Ffortum-and-sitra-increased-their-contribution-to-wave-energy-technology.aspx&ei=2dxlVJrnDla40M-agOgB&usq=AFQJCN-H6FUmeX1I29nnG38Tw1kue5Jkz5Q&sig2=GEh-dr_2zDrbb5t0ebsW9Vg&bvm=bv.79142246,d.ZWU.
- France Energies Marines (2014). *Parcs pilotes d'hydroliennes en France – France Energies Marines*. URL: <http://www.france-energies-marines.org/Actualites/Quoi-de-neuf/Parcs-pilotes-d-hydroliennes-en-France>.
- Fu *et al.* (2014). Fu, F.-J., Sun, S.-P., Zhang, S. & Chung, T.-S.: Pressure-Retarded Osmosis Dual-Layer Hollow-Fiber Membranes Developed by Co-casting Method and Ammonium Persulfate (APS) Treatment. *Journal of Membrane Science* 469 (488–498). DOI: 10.1016/j.memsci.2014.05.063.
- Fujita *et al.* (2012). Fujita, R., Markham, A. C., Diaz, J. E. *et al.*: Revisiting Ocean Thermal Energy Conversion. *Marine Policy* 36 (463–465). DOI: 10.1016/j.marpol.2011.05.008.
- Gerstandt *et al.* (2008). Gerstandt, K., Peinemann, K.-V., Skilhagen, S. E. *et al.*: Membrane Processes in Energy Supply for an Osmotic Power Plant. *Desalination* 224 (64–70). DOI: 10.1016/j.desal.2007.02.080.
- Giebardt *et al.* (2014). Giebardt, J., Kracht, P., Dick, C. & Salcedo, F.: *Report on Grid Integration and Power Quality Testing*. Deliverable 4.3 final. MaRINET.
- Gilmore *et al.* (2014). Gilmore, E. A., Blohm, A. & Sinsabaugh, S.: *An Economic and Environmental Assessment of Transporting Bulk Energy from a Grazing Ocean Thermal Energy Conversion Facility*. *Renewable Energy* 71 (361–367). DOI: 10.1016/j.renene.2014.05.021.
- Grimwade *et al.* (2012). Grimwade, J., Hails, D., Robles, E. *et al.*: *Review of Relevant PTO Systems*. D2.03. MaRINET, Cork.
- Güler *et al.* (2013). Güler, E., Elizen, R., Vermaas, D. A. *et al.*: Performance-Determining Membrane Properties in Reverse Electrodialysis. *Journal of Membrane Science* 446 (266–276). DOI: 10.1016/j.memsci.2013.06.045.
- Güler *et al.* (2014). Güler, E., Elizen, R., Saakes, M. & Nijmeijer, K.: Micro-Structured Membranes for Electricity Generation by Reverse Electrodialysis. *Journal of Membrane Science* 458 (136–148). DOI: 10.1016/j.memsci.2014.01.060.
- Han *et al.* (2013). Han, G., Zhang, S., Li, X. & Chung, T.-S.: High-Performance Thin-Film Composite Pressure-Retarded Osmosis (PRO) Membranes for Renewable Salinity-Gradient Energy Generation. *Journal of Membrane Science* 440 (108–121). DOI: 10.1016/j.memsci.2013.04.001.
- Held *et al.* (2006). Held, A., Ragwitz, M. & Haas, R.: On the Success of Policy Strategies for the Promotion of Electricity from Renewable Energy Sources in the EU. *Energy & Environment* 17 (849–868). DOI: 10.1260/095830506779398849.
- Herbert (2014). Herbert, S.: *Wave Hub Update*. All-Energy UK.
- Holcombe-Henley (2013). Holcombe-Henley, S.: *Ocean Energy in Europe's Atlantic Arc: An Overview of Policy and Market Conditions in Denmark, France, Ireland, Portugal, Spain and the United Kingdom*. Strategic Initiative for Ocean Energy (SI Ocean).
- Hong & Chen (2014). Hong, J. G. & Chen, Y.: Nanocomposite Reverse Electrodialysis (RED) Ion-Exchange Membranes for Salinity Gradient Power Generation. *Journal of Membrane Science* 460 (139–147). DOI: 10.1016/j.memsci.2014.02.027.
- House of Commons (2013). *A Severn Barrage? Government Response to the Committee's Second Report of Session 2013–14*. House of Commons Energy and Climate Change Committee.
- IEA-OES (2012). Anonymous: *Annual Report 2012. Implementing Agreement on Ocean Energy Systems*. IEA-OES, Lisboa.
- IEA-OES (2013). Anonymous: *Annual Report 2013. Implementing Agreement on Ocean Energy Systems*. IEA-OES, Lisboa.
- IEA-OES (2014a). *Annex V: The Exchange and Assessment of Ocean Energy Device Project Information and Experience*. URL: <http://www.ocean-energy-systems.org/about-oes/work-programme/annex-v-project-information/>.
- IEA-OES (2014b). *Annex II: Development of Recommended Practices for Testing and Evaluating Ocean Energy Systems*. URL: <http://www.ocean-energy-systems.org/annex-ii-guidelines/>.
- IEA-OES (2014c). *Annex IV: Assessment of Environmental Effects and Monitoring Efforts for Ocean Wave, Tidal, and Current Energy Systems*. URL: <http://www.ocean-energy-systems.org/about-oes/work-programme/annex-iv-environmental-issues/>.
- IEC (2015). IEC-TC 114 Scope. URL: http://www.iec.ch/dyn/www/f?p=103:7:0:::FSP_ORG_ID,FSP_LANG_ID:1316,25.
- IEEE Spectrum (2014). Strickland, E.: *Lockheed Martin Pioneers Ocean Energy in China*. URL: <http://spectrum.ieee.org/green-tech/geothermal-and-tidal/lockheed-martin-pioneers-ocean-energy-in-china>.
- INSA (2001). *Department of Ocean Development: Pursuit and Promotion of Science: The Indian Experience*. Indian National Science Academy, New Delhi.

- IRENA (2014a). Kempener, R. & Neumann, F.: Tidal Energy. International Renewable Energy Agency (IRENA), Abu Dhabi/Bonn.
- IRENA (2014b). Mofor, L., Goldsmith, J. & Jones, F.: Ocean Energy. Technology Readiness, Patents, Deployment Status and Outlook. International Renewable Energy Agency (IRENA), Abu Dhabi.
- IRENA (2014c). Kempener, R. & Neumann, F.: Ocean Thermal Energy Conversion. International Renewable Energy Agency (IRENA), Abu Dhabi/Bonn.
- IRENA (2014d). Kempener, R. & Neumann, F.: Salinity Gradient Energy. International Renewable Energy Agency (IRENA), Abu Dhabi/Bonn.
- Jones & Finley (2003). Jones, A. T. & Finley, W.: Recent Developments in Salinity Gradient Power. Marine Technology Society OCEANS 2003.
- JRC (2014). JRC Ocean Energy Database.
- Knowledge Transfer Network (2014). DECC Marine Energy Array Demonstrator (MEAD) Capital Grant Scheme. URL: <http://www.lowcarbonfunding.org.uk/opportunity/decc-marine-energy-array-demonstrator-mead-capital-grant-scheme-15.htm>. Accessed: 8 October 2014.
- Lacal Arántegui (2014). Lacal Arántegui, R.: 2013 JRC Wind Status Report. Publications Office of the European Union, Luxembourg.
- Lacey (1980). Lacey, R. E.: Energy by Reverse Electrolysis. *Ocean Engineering* 7 (1–47). DOI: 10.1016/0029-8018(80)90030-X.
- Lewis *et al.* (2011). Lewis, A., Estefen, S., Huckerby, J. *et al.*: Ocean Energy. Cambridge University Press, Cambridge/New York.
- Lienard & Neumann (2011). Neumann, F., Stenzel, P., Hack, P. *et al.*: Salinity Gradient Power in Europe: State of the Art. Institute for Infrastructure, Environment and Innovation, Brussels.
- Lynn (2013). Lynn, P. A.: Electricity from Wave and Tide: An Introduction to Marine Energy. John Wiley & Sons.
- MacGillivray *et al.* (2013). MacGillivray, A., Jeffrey, H., Hanmer, C. *et al.*: Ocean Energy Technology: Gaps and Barriers. Strategic Initiative for Ocean Energy (SI Ocean).
- Magagna (2011). Magagna, D.: Oscillating Water Column Wave Pump: A Wave Energy Converter for Water Delivery.
- Magagna *et al.* (2014). Magagna, D., MacGillivray, A., Jeffrey, H. *et al.*: Wave and Tidal Energy Strategic Technology Agenda. Strategic Initiative for Ocean Energy (SI Ocean).
- Marine Institute (2014). €200 Million Earmarked for Marine Research in the EU's Horizon 2020 Programme in 2014–2015. URL: <https://www.marine.ie/home/aboutus/newsroom/news/€200millionearmarkedformarinere-searchintheEUshorizon2020programmein2014-2015.htm>. Accessed: 10 October 2014.
- Maritime Executive (2014). Schottel Hydro Focusing on Hydrokinetic Energy. URL: <http://www.maritime-executive.com/pressrelease/SCHOTTEL-HYDRO-Focusing-on-Hydrokinetic-Energy--2014-11-07>.
- Martel *et al.* (2012). Martel, L., Smith, P., Rizea, S. *et al.*: Ocean Thermal Energy Conversion Life Cycle Cost Assessment. Final Technical Report. Manassas.
- MCT (2014). Siemens, Bluewater and Minas to Install Floating Tidal Current Turbines in Canada's Bay of Fundy. URL: <http://www.marineturbines.com/News/2014/04/04/siemens-bluewater-and-minas-install-floating-tidal-current-turbines-canadas-bay>.
- Meyer *et al.* (2011). Meyer, L., Cooper, D. & Varley, R.: Are We There Yet? A Developer's Roadmap to OTEC Commercialization. OCEANS' 11 MTS/IEEE KONA. Hawaii National Marine Renewable Energy Center, Kona.
- MeyGen (2014a). Technology. URL: <http://www.meygen.com/technology/>.
- MeyGen (2014b). Development Phases. URL: <http://www.meygen.com/the-project/development-phases/>. Accessed: 16 September 2014.
- Minesto (2014a). Minesto: Deep Green – Technical Data. Minesto, Västra Frölunda.
- Minesto (2014b). DECC Awards over £500,000 for the Continued Development of the Deep Green Tidal Power Plant. URL: <http://minesto.com/decc-awards-over-500000-for-the-continued-development-of-the-deep-green-tidal-power-plant/>. Accessed: 19 November 2014.
- Minesto (2014c). Wales Takes the Lead in Marine Energy. URL: <http://minesto.com/wales-takes-the-lead-in-marine-energy/>. Accessed: 19 November 2014.
- Molenbroek (2007). Molenbroek, E. C.: Energie uit zout en zoet water met osmose. Rijkswaterstaat, Utrecht.
- Murthy *et al.* (2004). Murthy, P. Sriyutha, Venkatesan, R., Nair, K. V. K. & Ravindran, M.: Biofilm Control for Plate Heat Exchangers Using Surface Seawater from the Open Ocean for the OTEC Power Plant. *International Biodeterioration & Biodegradation* 53 (133–140).
- NELHA (2014). NELHA Energy Portfolio. URL: <http://nelha.hawaii.gov/energy-portfolio/>.
- Nickels *et al.* (1981). Nickels, J. S., Bobbie, R. J., Lott, D. F. *et al.*: Effect of Manual Brush Cleaning on Biomass and Community Structure of Microfouling Film Formed on Aluminum and Titanium Surfaces Exposed to Rapidly Flowing Seawater. *Applied and Environmental Microbiology* 41 (1442–1453).
- Nihous (2007). Nihous, G. C.: A Preliminary Assessment of Ocean Thermal Energy Conversion Resources. *Journal of Energy Resources Technology* 129 (10). DOI: 10.1115/1.2424965.
- Nihous (2010). Nihous, G. C.: Mapping Available Ocean Thermal Energy Conversion Resources around the Main Hawaiian Islands with State-of-the-Art Tools. *Journal of Renewable and Sustainable Energy* 2 (043104). DOI: 10.1063/1.3463051.
- OceaneraNET (2014). OceaneraNET – Joint Calls (1.0.0). URL: <http://www.oceaneranet.eu/pages/joint-calls-8.html>. Accessed: 14 November 2014.
- Offshore Wind (2014). MeyGen Enters Construction Phase. URL: http://www.offshorewind.biz/2014/11/25/meygen-enters-construction-phase/?utm_source=emark&utm_medium=email&utm_campaign=Daily+update+Offshore+Wind,+2014-11-26&uid=3513. Accessed: 27 November 2014.
- Ofgem (2014). Ofgem Renewables and CHP Register. URL: <https://www.renewablesandchp.ofgem.gov.uk/>. Accessed: 19 November 2014.
- Olsson (1982). Olsson, M. S.: Salinity-Gradient Vapor-Pressure Power Conversion. *Energy* 7 (237–246). DOI: 10.1016/0360-5442(82)90072-X.
- Olsson *et al.* (1979). Olsson, M., Wick, G. L. & Isaacs, J. D.: Salinity Gradient Power: Utilizing Vapor Pressure Differences. *Science (New York, NY)* 206 (452–4). DOI: 10.1126/science.206.4417.452.
- Orden IET/1045/2014 (2014). Orden IET/1045/2014, de 16 de junio, por la que se aprueban los parámetros retributivos de las instalaciones tipo aplicables a determinadas instalaciones de producción de energía eléctrica a partir de fuentes de energía renovables, cogeneración y residuos.

- ORECCA (2011). Jeffrey, H. & Sedgwick, J.: ORECCA – European Offshore Renewable Energy Roadmap.
- O’Sullivan & Dalton (2009). O’Sullivan, D. & Dalton, G.: Challenges in the Grid Connection of Wave Energy Devices. Proceedings of the 8th European Wave and Tidal Energy Conference (EWTEC 2009).
- OTE (2014a). Past Successes. URL: http://www.otecorporation.com/past_strategic_initiatives.html.
- OTE (2014b). Current Projects. URL: http://www.otecorporation.com/present_strategic_initiatives.html.
- OTEC News (2013). 100-kilowatt Turbine-Generator for Kona Test Facility. URL: <http://www.otecnews.org/2013/03/100-kilowatt-turbine-generator-for-kona-test-facility/>.
- OTEC News (2014a). 20kW OTEC Pilot Plant Public Demonstration in South Korea. URL: <http://www.otecnews.org/2014/01/20kw-otec-pilot-plant-public-demonstration-south-korea/>.
- OTEC News (2014b). OTEC Testing in the Indian Ocean. URL: <http://www.otecnews.org/2013/04/otec-testing-in-the-indian-ocean/>.
- OTEC News (2014c). Funding NEMO: Offshore OTEC Project Awarded in NER 300 Program. URL: <http://www.otecnews.org/2014/07/offshore-otec-project-nemo-awarded-ner-300-funding-program/>.
- OTEC Okinawa (2014). The Okinawa Prefecture Ocean Thermal Energy Conversion Power Generation Demonstration Project. URL: <http://otecokinawa.com/en/>.
- OTI (2013). O’Rourke, E.: A Developer’s Perspective. Asia Pacific Clean Energy Summit International OTEC Symposium.
- OTI (2014). OTEC International LLC Moves Forward on NELHA Planning. URL: <http://www.oteci.com/press-releases/otec-international-llc-moves-forward-on-nelha-planning>.
- Patel (2013). Patel, S.: OTEC Gets Boost with Possibility of 10MW Plant in China. *Power* 157.
- Patel *et al.* (2014). Patel, R., Chi, W. S., Ahn, S.H. *et al.*: Synthesis of Poly(vinyl chloride)-g-poly(3-sulfopropyl methacrylate) Graft Copolymers and Their Use in Pressure-Retarded Osmosis (PRO) Membranes. *Chemical Engineering Journal* 247 (1–8). DOI: 10.1016/j.cej.2014.02.106.
- Pattle (1954). Pattle, R. E.: Production of Electric Power by Mixing Fresh and Salt Water in the Hydroelectric Pile. *Nature* 174 (660). DOI: 10.1038/174660a0.
- Pelamis (2014). A Decade of Wave Power. URL: <http://www.pelamiswave.com/news/news/167/A-decade-of-wave-power>. Accessed: 14 November 2014.
- Pelc & Fujita (2002). Pelc, R. & Fujita, R. M.: Renewable Energy from the Ocean. *Marine Policy* 26 (471–479). DOI: 10.1016/S0308-597X(02)00045-3.
- Plocek *et al.* (2009). Plocek, T. J., Laboy, M. & Martí, J. A.: Ocean Thermal Energy Conversion (OTEC): Technical Viability, Cost Projections and Development Strategies. 2009 Offshore Technology Conference.
- Post *et al.* (2007). Post, J. W., Veerman, J., Hamelers, H. V. M. *et al.*: Salinity-Gradient Power: Evaluation of Pressure-Retarded Osmosis and Reverse Electrodialysis. *Journal of Membrane Science* 288 (218–230). DOI: 10.1016/j.memsci.2006.11.018.
- Post *et al.* (2010). Post, J. W., Goeting, C. H., Valk, J. *et al.*: Towards Implementation of Reverse Electrodialysis for Power Generation from Salinity Gradients. *Desalination and Water Treatment* 16 (182–193). DOI: 10.5004/dwt.2010.1093.
- Power Technology (2014). Statkraft Osmotic Power Plant, Norway. URL: <http://www.power-technology.com/projects/statkraft-osmotic/>.
- Preda *et al.* (2012). Preda, T.-N., Uhlen, K. & Nordgård, D. E.: An Overview of the Present Grid Codes for Integration of Distributed Generation. CIRED 2012 Workshop: Integration of Renewables into the Distribution Grid. IET.
- Pullen *et al.* (2009). Pullen, A., Hays, K. & Knolle, G.: Wind Energy – The Facts. Part IV – Industry and Markets.
- Rajagopalan & Nihous (2013). Rajagopalan, K. & Nihous, G. C.: An Assessment of Global Ocean Thermal Energy Conversion Resources under Broad Geographical Constraints. *Journal of Renewable and Sustainable Energy* 5. DOI: 10.1063/1.4850521.
- Ravilious (2009). Ravilious, K.: Salt Solution: Cheap Power from the River’s Mouth. *New Scientist* (40–43).
- Real Decreto 413/2014 (2014). Real Decreto 413/2014, de 6 de junio, por el que se regula la actividad de producción de energía eléctrica a partir de fuentes de energía renovables, cogeneración y residuos.
- Redstack (2014). Pilot Plant of Salinity Gradient Power Generation by Reverse Electro Dialysis is Making Good Progress. URL: http://www.redstack.nl/index.php?option=com_content&view=article&id=30_3aprogress-blue-energy-generation-by-red&catid=2_3aalerts&itemid=6.htm.
- Renew Economy (2014). Vorrath, S.: Wave Energy Company Oceanlinx Goes into Receivership. URL: <http://reneweconomy.com.au/2014/wave-energy-company-oceanlinx-goes-into-receivership-89508>.
- Renewable Energy Focus (2014). Pelamis Wave Power Limited to be Put into Administration. URL: <http://www.renewableenergyfocus.com/view/40731/pelamis-wave-power-limited-to-be-put-into-administration/>. Accessed: 28 November 2014.
- ReNews (2014a). Cash Awards Buoy PLAT-O Tidal. URL: <http://renews.biz/72478/cash-awards-buoy-plat-o-tidal/>.
- ReNews (2014b). Ceto 5 Comes Alive for Carnegie. URL: <http://renews.biz/79763/ceto-5-comes-alive-for-carnegie/>. Accessed: 28 November 2014.
- Roll Call (2014). Leonard, R.: Ocean Thermal Gets a Second Chance. URL: <http://blogs.rollcall.com/energy-xtra/ocean-thermal-gets-a-second-chance/?dcz=>.
- Sabella (2014). L’entreprise. URL: <http://www.sabella.fr/fiche.php?id=1>.
- Schottel (2013). Schottel Tidal Generator: Cost-Effective Power from Currents. Schottel, Spay.
- Schottel (2014). Sustainable Marine Energy Deploys Schottel Turbines on Tidal Platform. URL: [http://www.schottel.de/news-events/news/news-detail/?tx_ttnews\[tt_news\]=121&cHash=6a64a47af95dc742fd50a1a605a43f8f](http://www.schottel.de/news-events/news/news-detail/?tx_ttnews[tt_news]=121&cHash=6a64a47af95dc742fd50a1a605a43f8f).
- Scott (2007). Scott, N. C.: European Practices with Grid Connection, Reinforcement, Constraint and Charging of Renewable Energy Projects.
- Scottish Government, The (2014). The Scottish Government: Wave Energy Scotland. URL: <http://www.scotland.gov.uk/Resource/0046/00464410.pdf>. Accessed: 28 November 2014.
- Scottish Renewables (2014). Marine Milestones Report 2012/13. Scottish Renewables, Glasgow.
- SEIA (2013). Ocean Energy Development Unit Prototype Development Fund – Call for Expressions of Interest. Sustainable Energy Authority of Ireland (SEIA).

- Semmari *et al.* (2012). Semmari, H., Stitou, D. & Mauran, S.: A Novel Carnot-Based Cycle for Ocean Thermal Energy Conversion. *Energy* 43 (361–375). DOI: 10.1016/j.energy.2012.04.017.
- SERI (1989). *Ocean Thermal Energy Conversion: An Overview*. Golden.
- She *et al.* (2013). She, Q., Hou, D., Liu, J. *et al.*: Effect of Feed-Spacer-Induced Membrane Deformation on the Performance of Pressure-Retarded Osmosis (PRO): Implications for PRO Process Operation. *Journal of Membrane Science* 445 (170–182). DOI: 10.1016/j.memsci.2013.05.061.
- Sheng (2013). Sheng, S.: Report on Wind Turbine Subsystem Reliability A Survey of Various Databases. National Renewable Energy Laboratory (NREL).
- SI Ocean (2013a). Anonymous: Ocean Energy: State of the Art. Strategic Initiative for Ocean Energy (SI Ocean).
- SI Ocean (2013b). Anonymous: Ocean Energy: Cost of Energy and Cost Reduction Opportunities. Strategic Initiative for Ocean Energy (SI Ocean).
- Skilhagen *et al.* (2008). Skilhagen, S. E., Dugstad, J. E. & Aaberg, R. J.: Osmotic Power – Power Production Based on the Osmotic Pressure Difference between Waters with Varying Salt Gradients. *Desalination* 220 (476–482). DOI: 10.1016/j.desal.2007.02.045.
- Skråmestø *et al.* (2009). Skråmestø, Ø. S., Skilhagen, S. E. & Nielsen, W. K.: Power Production Based on Osmotic Pressure. *Waterpower XVI*.
- SOWFIA (2011). Osta Mora-Figuera, V., Huerta Olivares, C., Holmes, B. *et al.*: Catalogue of Wave Energy Test Centres. Plymouth.
- SOWFIA (2013a). Simas, T., O'Hagan, A. M., O'Callaghan, J. *et al.*: Review of Consenting Processes for Ocean Energy in Different EU Member States.
- SOWFIA (2013b). Simas, T., O'Hagan, A. M., Bailey, I. *et al.*: Consenting Procedures Review with Guidelines for Expansion to Larger Projects and Approval Process Streamlining, Incorporating the Findings of Interim Report and Feedback from Workshop D.
- Statkraft (2014). Statkraft Halts Osmotic Power Investments. URL: <http://www.statkraft.com/media/news/News-archive/2013/Statkraft-halts-osmotic-power-investments/>.
- Stenzel (2012). Stenzel, P.: *Potentiale der Osmose zur Erzeugung und Speicherung von Elektrizität*. Lit Verlag, Münster.
- Straatman & van Sark (2008). Straatman, P. J. T. & van Sark, W. G. J. H. M.: A New Hybrid Ocean Thermal Energy Conversion – Offshore Solar Pond (OTEC – OSP) Design: A Cost-Optimization Approach. *Solar Energy* 82 (520–527). DOI: 10.1016/j.solener.2007.12.002.
- SWD(2014)13 (2014a). European Commission: Commission Staff Working Document Impact Assessment accompanying the document: Communication from the Commission to the European Parliament, the Council, the European Economic and Social Committee and the Committee of the Regions: Ocean Energy Action Needed. Brussels.
- SWD(2014)13 (2014b). European Commission: Impact Assessment accompanying the document: Blue Energy: Action Needed to Deliver on the Potential of Ocean Energy in European Seas and Oceans by 2020 and Beyond. Brussels.
- Tethys (2014a). MeyGen Tidal Energy Project – Phase I. URL: <http://tethys.pnnl.gov/annex-iv-sites/meygen-tidal-energy-project-phase-i>.
- Tethys (2014b). Environmental Effects Metadata Survey Form – Kyle Rhea Tidal Stream Array Project. Sea Generation Ltd.
- Tethys (2014c). Environmental Effects Metadata Survey Form – Sound of Islay Demonstration Tidal Array. ScottishPower Renewables.
- Thorsen & Holt (2009). Thorsen, T. & Holt, T.: The Potential for Power Production from Salinity Gradients by Pressure-Retarded Osmosis. *Journal of Membrane Science* 335 (103–110). DOI: 10.1016/j.memsci.2009.03.003.
- Tidal Today (2014a). Siemens-MCT Skerries Project Suspended over Finance. URL: <http://social.tidaltoday.com/finance/siemens-mct-skerries-project-suspended-over-finance>. Accessed: 19 November 2014.
- Tidal Today (2014b). Tidal Today: Global Tidal Marine Development Market Overview 2014.
- Trayner (2014). Trayner, P.: Flumill and RES Update. All-Energy Conference 2014.
- Upshaw (2012). Upshaw, C. R.: Thermodynamic and Economic Feasibility Analysis of a 20MW Ocean Thermal Energy Conversion (OTEC) Power. Masters Thesis, Graduate School, University of Texas at Austin.
- US DOE (2014). Water Power Program: Marine and Hydrokinetic (MHK) System Performance Advancement. URL: http://www1.eere.energy.gov/water/m/financial_opps_detail.html?sol_id=599.
- van den Ende & Groemann (2007). van den Ende, K. & Groemann, F.: Briefing Paper – Blue Energy. Leonardo Energy.
- Vega (2002). Vega, L. A.: Ocean Thermal Energy Conversion Primer. *Marine Technology Society Journal* 6 (25–35).
- Vermaas (2013). Vermaas, D. A.: Energy Generation from Mixing Salt Water and Fresh Water. University of Twente.
- Wang *et al.* (2011). Wang, S., Yuan, P., Li, D. & Jiao, Y.: An Overview of Ocean Renewable Energy in China. *Renewable and Sustainable Energy Reviews* 15 (91–111). DOI: 10.1016/j.rser.2010.09.040.
- WEC (2013). World Energy Resources 2013 Survey. World Energy Council (WEC), London.
- Weller *et al.* (2013). Weller, S., Johanning, L. & Davies, P.: Best Practice Report – Moorings of Floating Marine Renewable Energy Devices.
- Weller *et al.* (2014). Weller, S., Hardwick, J., Johanning, L. *et al.*: A Comprehensive Assessment of the Applicability of Available and Proposed Offshore Mooring and Foundation Technologies and Design Tools for Array Applications. Edinburgh, UK.
- Whitlock (2014). Whitlock, R.: EGP and DCNS to Develop Marine Energy R&D Facility in Chile. URL: <http://www.renewableenergymagazine.com/article/egp-and-dcns-to-develop-marine-energy-20141030>.
- World Ocean Atlas (2013a). Locarnini, R. A., Mishonov, A. V., Antonov, J. I. *et al.*: World Ocean Atlas 2013. Volume 1: Temperature. National Oceanic and Atmospheric Administration (NOAA), Silver Spring.
- World Ocean Atlas (2013b). Zweng, M., Reagan, J. R., Antonov, J. I. *et al.*: World Ocean Atlas 2013. Volume 2: Salinity. National Oceanic and Atmospheric Administration (NOAA), Silver Spring.
- Yang & Yeh (2014). Yang, M.-H. & Yeh, R.-H.: Analysis of Optimization in an OTEC Plant Using Organic Rankine Cycle. *Renewable Energy* 68 (25–34). DOI: 10.1016/j.renene.2014.01.029.

Yoon *et al.* (2014). Yoon, J.-I., Son, C.-H., Baek, S.-M. *et al.*: Efficiency Comparison of Subcritical OTEC Power Cycle Using Various Working Fluids. *Heat and Mass Transfer* 50 (985–996). DOI: 10.1007/s00231-014-1310-8.

Yu *et al.* (2013). Yu, S., Yao, G., Dong, B. *et al.*: Improving Fouling Resistance of Thin-Film Composite Polyamide Reverse Osmosis Membrane by Coating Natural Hydrophilic Polymer Sericin. *Separation and Purification Technology* 118 (285–293). DOI: 10.1016/j.seppur.2013.07.018.

Yuan *et al.* (2013). Yuan, H., Mei, N., Hu, S. *et al.*: Experimental Investigation on an Ammonia–Water- Based Ocean Thermal Energy Conversion System. *Applied Thermal Engineering* 61 (327–333). DOI: 10.1016/j.applthermaleng.2013.07.050.

Zhou *et al.* (2014). Zhou, C., Ye, D., Jia, H. *et al.*: Surface Mineralization of Commercial Thin-Film Composite Polyamide Membrane by Depositing Barium Sulfate for Improved Reverse Osmosis Performance and Antifouling Property. *Desalination* 351 (228–235). DOI: 10.1016/j.desal.2014.07.040.

Europe Direct is a service to help you find answers to your questions about the European Union
Freephone number (*): 00 800 6 7 8 9 10 11

(*): Certain mobile telephone operators do not allow access to 00 800 numbers or these calls may be billed.

A great deal of additional information on the European Union is available on the Internet.
It can be accessed through the Europa server <http://europa.eu>.

How to obtain EU publications

Our publications are available from EU Bookshop (<http://bookshop.europa.eu>),
where you can place an order with the sales agent of your choice.

The Publications Office has a worldwide network of sales agents.
You can obtain their contact details by sending a fax to (352) 29 29-42758.

European Commission

EUR 26983 EN – Joint Research Centre – Institute for Energy and Transport

Title: 2014 JRC Ocean Energy Status Report

Authors: Davide Magagna, Andreas Uihlein

Luxembourg: Publications Office of the European Union

2015 – 70 pp. – 21.0 x 29.7 cm

EUR – Scientific and Technical Research series – ISSN 1831-9424

ISBN 978-92-79-44611-5

doi: 10.2790/866387

JRC Mission

As the Commission's in-house science service, the Joint Research Centre's mission is to provide EU policies with independent, evidence-based scientific and technical support throughout the whole policy cycle.

Working in close cooperation with policy Directorates-General, the JRC addresses key societal challenges while stimulating innovation through developing new methods, tools and standards, and sharing its know-how with the Member States, the scientific community and international partners.

Serving society
Stimulating innovation
Supporting legislation

doi: 10.2790/866387
ISBN 978-92-79-44611-5

